

Myriad LED
2017409 2017410
 Myriad LED Emergency
2017411

Disconnect from mains supply before replacing the fuse or the lamp.
 Vor dem Einsetzen der Sicherung oder der Lampe Spannungsfreiheit herstellen.
Débrancher le secteur avant de remplacer le fusible ou l'ampoule.
 Desconectar del suministro de la red, antes de realizar la sustitución del fusible o de la lámpara.
Voor het vervangen van lamp of zekering, eerst netspanning uitschakelen.
 Koppla bort spänningen före byte av en säkring eller en lampa.

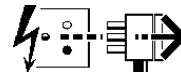

Switch Off
 Abschalten
Couper le conector
 Desconectar
Uitschakelen
 Stäng av

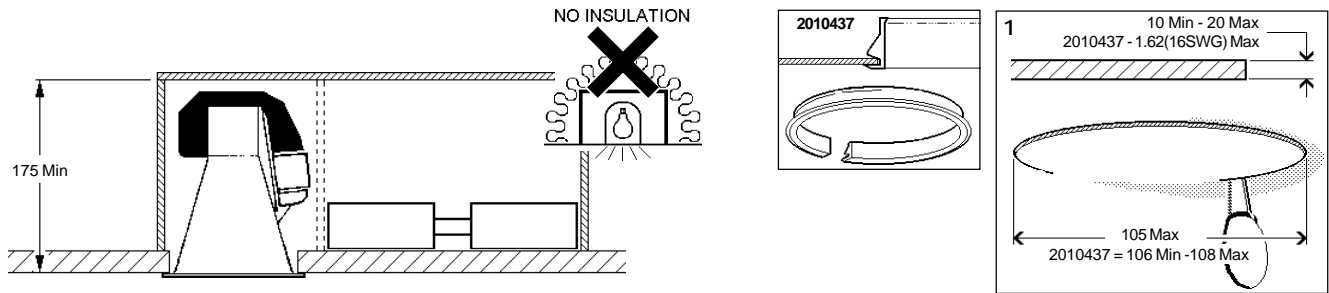

2017409 2017410

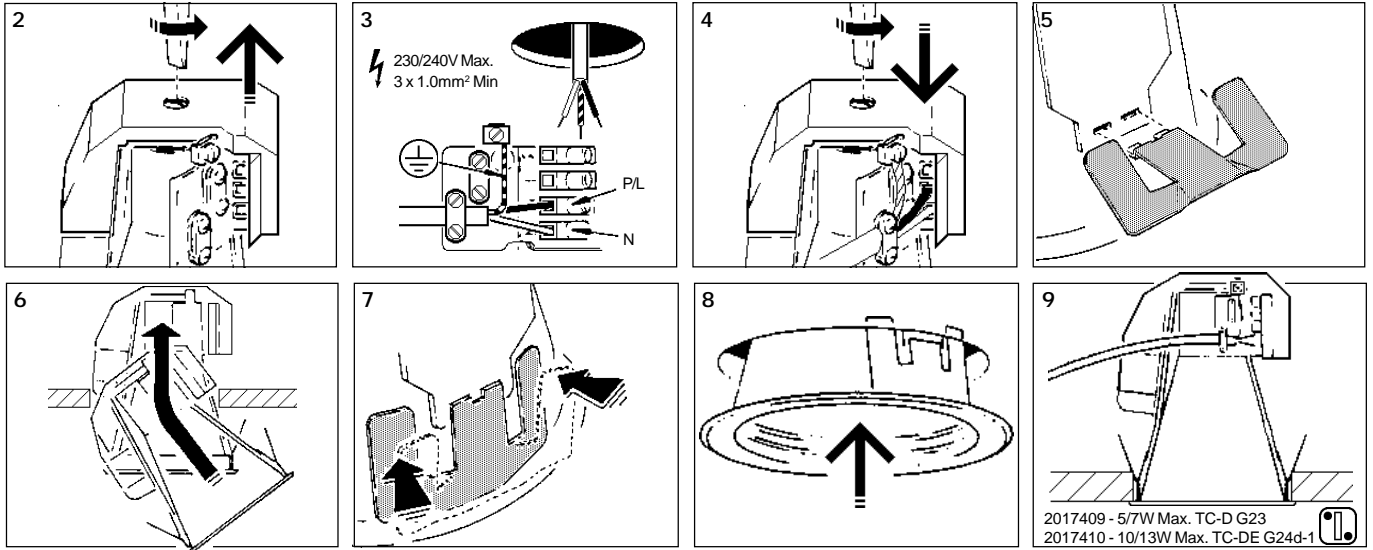

2017411

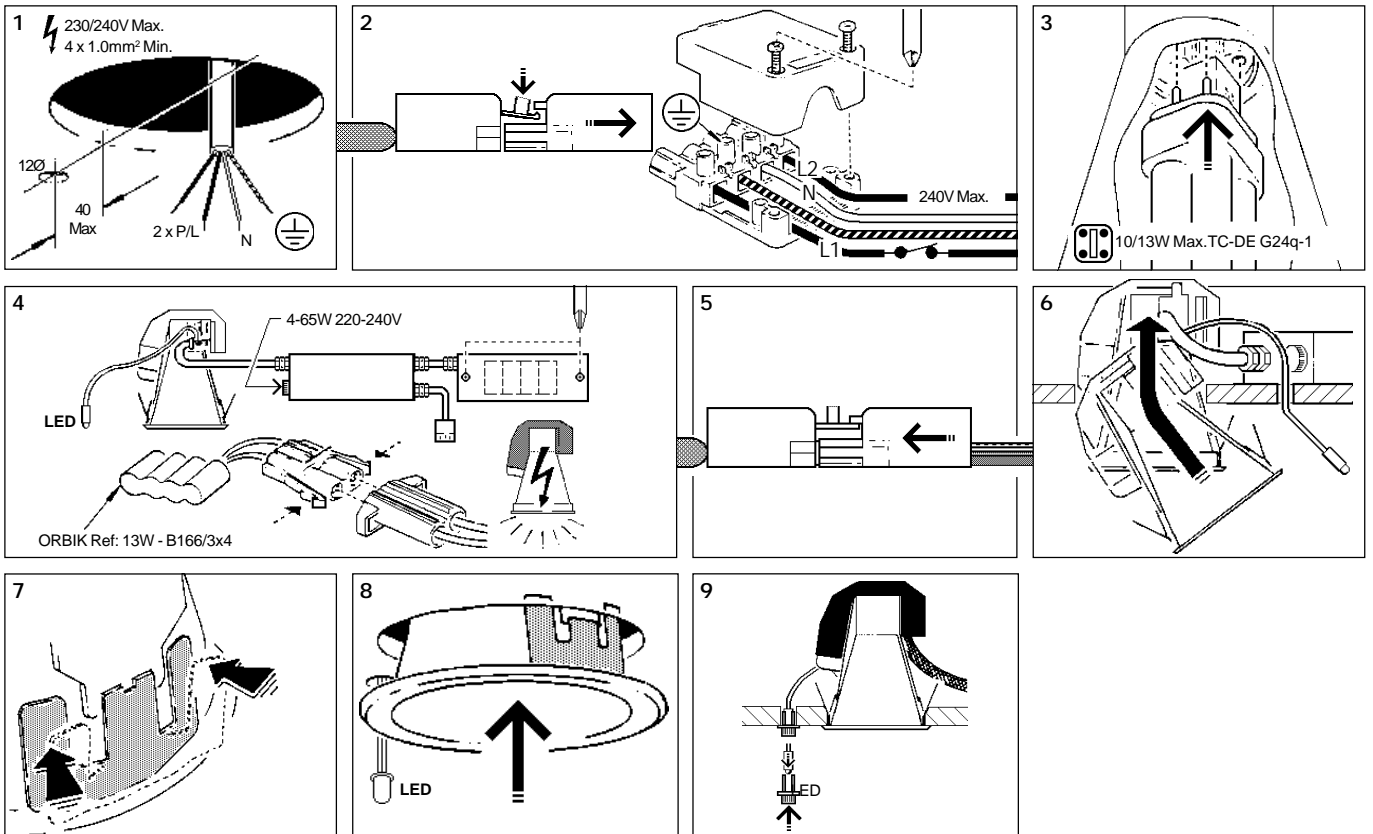

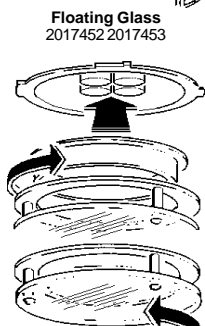
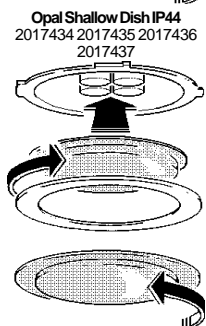
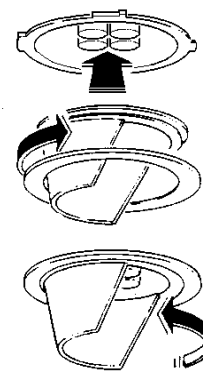
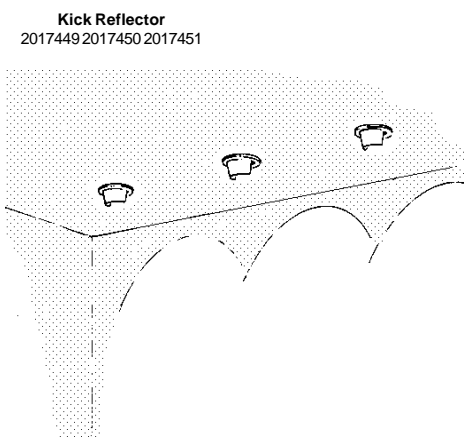
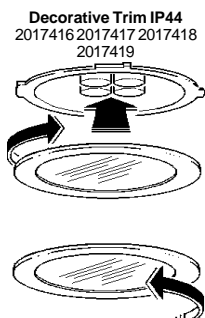
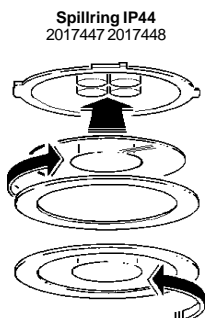

Routine Maintenance

Routine maintenance must be carried out in compliance with the requirements of BS5266:Part 1 - Emergency Lighting of Premises.

The following tests assume a three-hour system.

- Daily:**
1. Check that any recorded faults have been rectified.
 2. Check that the maintained emergency lamp is operative.
 3. Check that the charge indicator light is illuminated.
- Monthly:**
(Functional)
1. Simulate a mains failure and check that the emergency lamp illuminates and remains on for several minutes.
 2. After reverting back to mains supply check the charge indicator light is illuminated.
- Six Monthly:**
(1 Hour)
1. Simulate a mains failure and check that the emergency lamp illuminates and remains on for one hour.
 2. After reverting back to mains supply check the charge indicator light is illuminated.
 3. On restoring the mains supply the unit will require approximately 24 hours to recharge before becoming fully operational.
- Three Years:**
(3 Hours)
1. Simulate a mains failure and check that the emergency lamp illuminates and remains on for at least 3 hours.
 2. After reverting back to mains supply check the charge indicator light is illuminated.
 3. On restoring the mains supply the unit will require approximately 24 hours to recharge before becoming fully operational.

It is recommended that the battery packs and lamps are replaced every 4 years or sooner if the units performance fails to meet the above requirements. To maintain optimum unit performance, only approved replacement battery packs and lamps must be used.

All routine maintenance checks must be recorded on the unit Routine Test Record and must be made available for inspection at all times.

Installation and Commissioning Record

Luminaire Model Ref: _____ Location: _____

Installed By: _____ Date: _____

Commissioned by: _____ Date: _____
(Full Charge and Discharge Cycle)

Routine Test Record

Monthly Test	First Year		Second Year		Third Year		Forth Year		Fifth Year	
	Signed	Dated	Signed	Dated	Signed	Dated	Signed	Dated	Signed	Dated
Functional										
Functional										
Functional										
Functional										
Functional										
1 Hour Duration										
Functional										
Functional										
Functional										
Functional										
Functional										
1 Hour Duration										
3 Hour Duration										

Suitable for use indoors
Geeignet für Innenanwendung
Pour un usage interne
Adecuada para uso en interiores
Geschikt voor gebruik binnen
Lämplig för inomhusbruk



Replace any cracked protective shield.
Dieses symbol bedeutet, dass defekte Schutzgläser sofort ersetzt werden müssen.
Ce symbole indique que vous devez remplacer tout verre de protection fêlé.
Este simbolo indica que hay que reemplazar filtros en caso de rotura o desperfectos.
Dette symbolet indikerer at alle ødelagte (sprukne) sikkerhetsglass må skiftes.
Valaisinta el saa käyttää ilman suoja-alasia vioittunut suoja-alasi on vaihdettava uuteen ennen valaisimen käyttööottoa.

Myriad is a registered trademark of Concord Lighting Limited.
These products are protected by the following trademark registrations: U.K.-1307938, Benelux-433598, International-525070, Sweden-209849, Finland-105583, Norway-136800, Denmark-6177/1989, Japan-2509585.

< Millimetres >



This Electrical Product
MUST be recycled.



02.08

Concord

Avis Way Newhaven East Sussex BN9 0ED
T 0870 606 2030 F 01273 512 688 email: information@concordmarlin.com

