

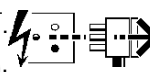

Installer Pack

| | |
|-----------------|-----------------|
| 2031502 = 1.5Kg | 2031503 = 1.5Kg |
| 2031504 = 1.5Kg | 2031505 = 1.5Kg |
| 2031510 = 1.5Kg | 2031511 = 1.5Kg |
| 2031512 = 1.5Kg | 2031513 = 1.5Kg |
| 2031520 = 1.9Kg | 2031521 = 1.9Kg |
| 2031522 = 1.9Kg | 2031523 = 1.9Kg |

Disconnect from mains supply before replacing the fuse or the lamp.
 Vor dem Einsetzen der Sicherung oder der Lampe Spannungsfreiheit herstellen.
Débrancher le secteur avant de remplacer le fusible ou l'ampoule.
 Desconectar del suministro de la red, antes de realizar la sustitución del fusible o de la lámpara.
Voor het vervangen van lamp of zekering, eerst netspanning uitschakelen.
 Koppla bort spänningen före byte av en säkring eller en lampa.



Switch Off
 Abschalten
Couper le connecteur
 Desconectar
Uitschakelen
 Stäng av

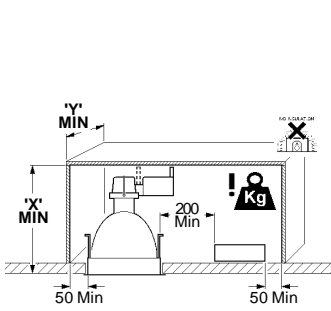

| F20 | | F44 | | Luminaire Only | |
|----------------|--------|----------------|--------|----------------|--------|
| Luminaire Only | | Installer Pack | | Luminaire Only | |
| X' MIN | Y' MIN | X' MIN | Y' MIN | X' MIN | Y' MIN |
| 2031536 = 270 | 380 | 2031502 = 230 | 380 | 2031548 = 230 | 335 |
| 2031537 = 270 | 380 | 2031503 = 230 | 380 | 2031550 = 230 | 335 |
| 2031538 = 195 | 300 | 2031504 = 190 | 300 | 2031551 = 190 | 300 |
| 2031540 = 195 | 300 | 2031505 = 190 | 300 | 2031552 = 190 | 300 |
| 2031544 = 280 | 380 | 2031510 = 230 | 380 | | |
| 2031545 = 280 | 380 | 2031511 = 230 | 380 | | |
| 2031546 = 260 | 380 | 2031512 = 190 | 300 | | |
| 2031547 = 260 | 380 | 2031513 = 190 | 300 | | |
| | | 2031520 = 235 | 380 | 2031558 = 235 | 335 |
| | | 2031521 = 235 | 380 | 2031560 = 235 | 335 |
| | | 2031522 = 215 | 380 | 2031561 = 215 | 335 |
| | | 2031523 = 215 | 380 | 2031562 = 215 | 335 |

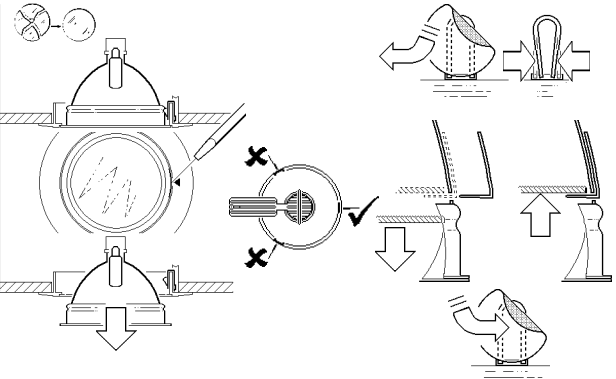
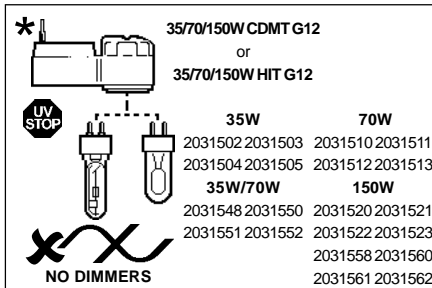
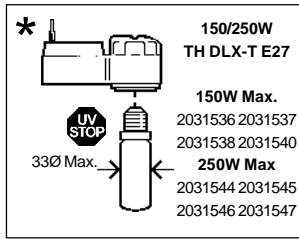
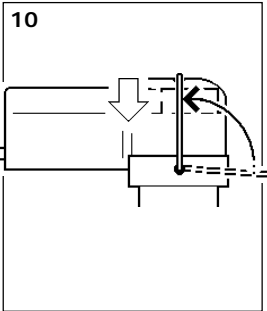
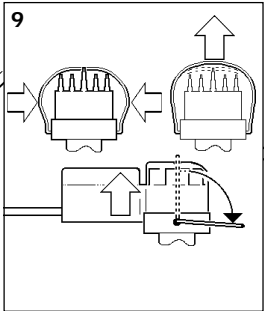
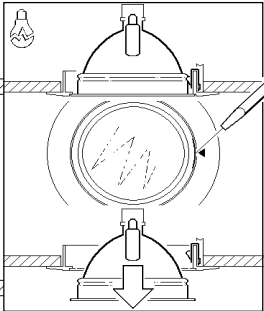
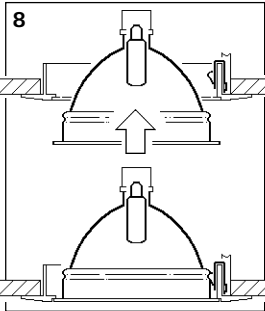
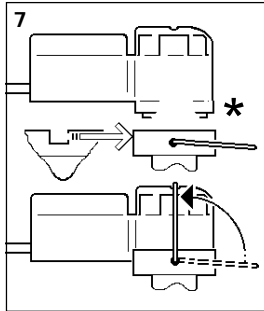
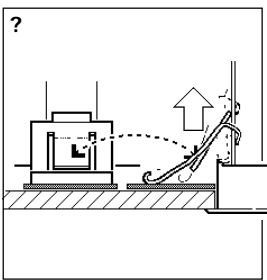
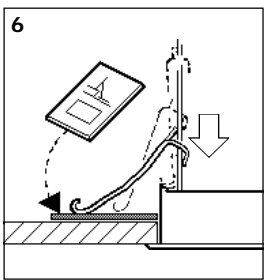
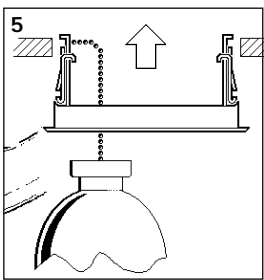
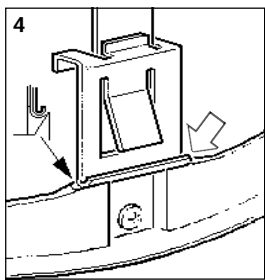
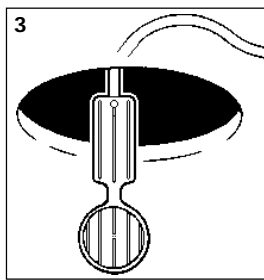
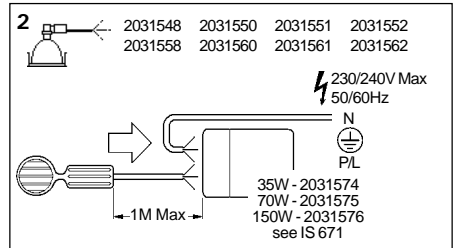
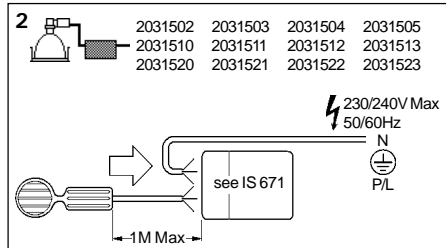
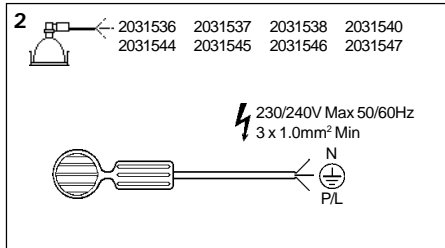
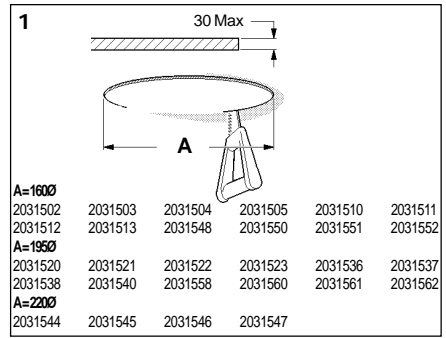

Suitable for use indoors
 Geeignet für Innenanwendung
 Pour un usage interne
 Adecuada para uso en interiores
 Geschikt voor gebruik binnen
 Lämplig för inomhusbruk

Replace any cracked protective shield.
 Dieses symbol bedeutet, dass defekte Schutzgläser sofort ersetzt werden müssen.
Ce symbol indique que vous devez remplacer tout verre de protection fêlé.
 Este simbolo indica que hay que reemplazar filtros en caso de rotura o desperfectos.
Dette symbolet indikerer at alle ødelagte (sprukne) sikkerhetglass må skiftes.
 Valaisinta ei saa käyttää ilman suojalasia vioittunutta suojalasia on vaihdettava uuteen ennen valaisimen käyttöön ottoa.

< Millimetres >



This Electrical Product MUST be recycled.

