

2038923 2038924 2038925 2038926 2038927  
2038928 2038930 2038931 2038932 2038933  
2038934 2038935 2038936 2038937 2038938  
2038940 2038941 2038942 2038943 2038944  
2039092 2039093 2039094 2039095 2040251  
2040252 2040254 2040255 2040256

**Disconnect from mains supply before replacing the fuse or the lamp.**  
Vor dem Einsetzen der Sicherung oder der Lampe Spannungsfreiheit herstellen.  
**Débrancher le secteur avant de remplacer le fusible ou l'ampoule.**  
Desconectar del suministro de la red, antes de realizar la sustitución del fusible o de la lámpara.  
**Voor het vervangen van lamp of zekering, eerst netspanning uitschakelen.**  
Koppla bort spänningen före byte av en säkring eller en lampa.

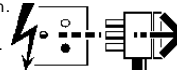

**Switch Off**  
Abschalten  
**Débrancher**  
Desconectar  
**Uitschakelen**  
Stäng av

**! Kg**  
Single = 1.2 Kgs  
Twin = 2.4 Kgs  
Triple = 3.6 Kgs  
Quad = 4.8 Kgs  
2 x 2 = 4.8 kgs

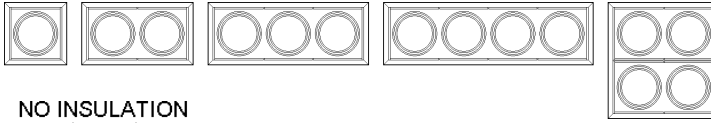

**NO INSULATION**

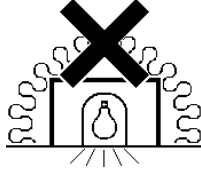

Not suitable for covering with thermally insulating material  
Ne doit pas être recouvert un matériau isolant thermique

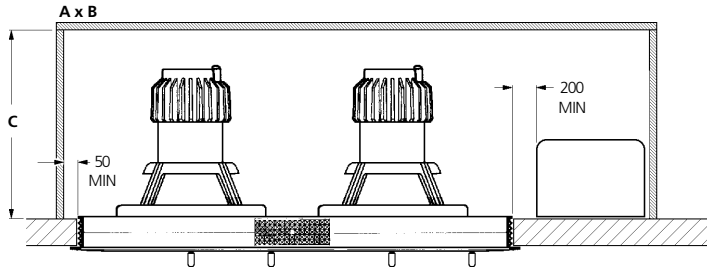

	A	B	C
⊕ 2038932	400	650	200
⊕ 2038933	550	650	200
⊕ 2038934	700	650	200
⊕ 2038935	850	650	200
⊕ 204255	650	650	200
⊕ 2038936	400	650	200
⊕ 2038937	550	650	200
⊕ 2038938	700	650	200
⊕ 2038940	850	650	200
⊕ 2040256	650	650	200
⊕ 2038923	400	450	140
⊕ 2038924	550	450	140
⊕ 2038925	700	450	140
⊕ 2038926	850	450	140
⊕ 2040251	650	650	140
⊕ 2038927	400	650	200
⊕ 2038928	550	650	200
⊕ 2038930	700	650	200
⊕ 2038931	850	650	200
⊕ 2040252	650	650	200
⊕ 2038941	400	650	200
⊕ 2038942	550	650	200
⊕ 2038943	700	650	200
⊕ 2038944	850	650	200
⊕ 2040254	650	650	200
⊕ 2039092	400	650	200
⊕ 2039093	550	650	200
⊕ 2039094	700	650	200
⊕ 2039095	850	650	200
⊕ 2040001	650	650	200

**1**

Single	Twin	Triple	Quad	2 x 2
2038932	2038933	2038934	2038935	2040251
2038936	2038937	2038938	2038940	2040255
2038923	2038924	2038925	2038926	2040256
2038927	2038928	2038930	2038931	2040252
2038941	2038944	2038943	2038944	2040001
2039092	2039093	2039094	2039095	2040254
=	=	=	=	=
<b>182 x 182</b>	<b>333 x 182</b>	<b>485 x 182</b>	<b>637 x 182</b>	<b>333 x 343</b>

**1?**

Single = 4 No  
Twin = 4 No  
Triple = 4 No  
Quad = 6 No  
2 x 2 = 4 No

1 x PVA + 5 x Water

**2**

Single = 4 No  
Twin = 4 No  
Triple = 4 No  
Quad = 6 No  
2 x 2 = 4 No

!0.5Nm  
MAX

**3** 230-240V~  
1.5mm<sup>2</sup> Min

⊕ 2038932 2038933 2038934 2038935 2040255  
2038936 2038937 2038938 2038940 2040256  
2038927 2038928 2038930 2038931 2040252  
2038941 2038942 2038943 2038944 2040254  
2039092 2039093 2039094 2039095 2040001

Single = 1 x 3 core P/L, N and ⊕  
Twin = 1 x 3 core P/L, N and ⊕  
Triple = 2 x 3 core P/L, N and ⊕  
Quad = 2 x 3 core P/L, N and ⊕  
2 x 2 = 2 x 3 core P/L, N and ⊕

⊕ 2038923 2038924 2038925  
2038926 2040251

Single = 1 x 2 core P/L, N  
Twin = 2 x 2 core P/L, N  
Triple = 3 x 2 core P/L, N  
Quad = 4 x 2 core P/L, N  
2 x 2 = 4 x 2 core P/L, N

**4**

2038927 2038928 2038930  
2038931 2038932 2038933  
2038934 2038935 2038936  
2038937 2038938 2038940  
2038941 2038942 2038943  
2038944 2039092 2039093  
2039094 2039095 2040252  
2040254 2040255 2040256

P/L N ⊕

IS671 - Electronic Control Gearboxes

**5**

**6**

2038932 2038933  
2038934 2038935  
2038936 2038937  
2038938 2038940  
2040255 2040256

**WARNING**  
DO NOT USE WITHOUT SAFETY GLASS  
**ACHTUNG**  
NICHT OHNE SICHERHEITSGLAS BENUTZEN  
**ATTENTION**  
NE PAS UTILISER SANS VERRRE DE PROTECTION  
**ADVERTENCIA**  
NO USAR SIN CRISTAL DE SEGURIDAD  
**VARNING**  
FÄR EJ ANVÄNDAS UTAN SKYDDSGLAS  
**WAARSCHUWING**  
NIET GEBRUIKEN ZONDER VEILIGHEIDGLAS

7

2038932 2038933 2038934 2038935 2040255  
35W CDM-T G12

2038936 2038937 2038938 2038940 2040256  
70W CDM-T G12

2038927 2038928 2038930 2038931 2040252  
35W ES111 BS Gx10

2039092 2039093 2039094 2039095 2040001  
70W ES111 BS Gx10

2038941 2038942 2038943 2038944 2040254  
35W CDM-R111 Gx8.5

2038923 2038924 2038925 2038926 2040251  
100W Max AR111 GU53

8

2038932 2038933  
2038934 2038935  
2038936 2038937  
2038938 2038940  
2040255 2040256

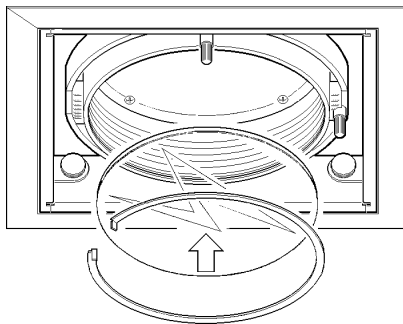

SAFETY GLASS



11° - Spot - 2027238



29° - Flood - 2027234



5:1 - Elongation - 2027239

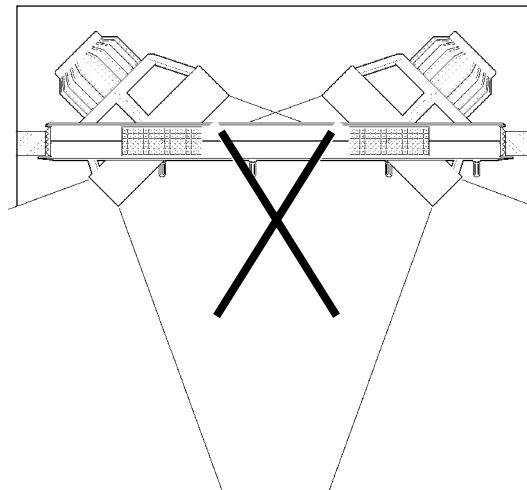
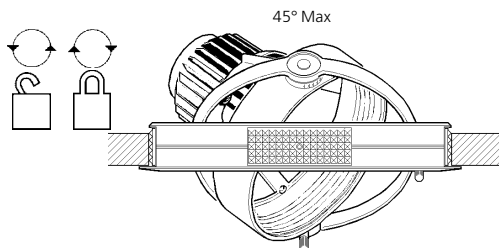
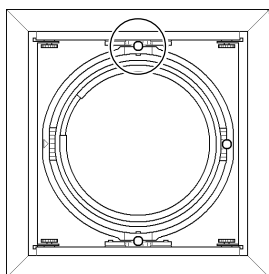
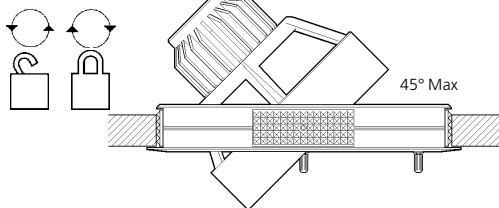
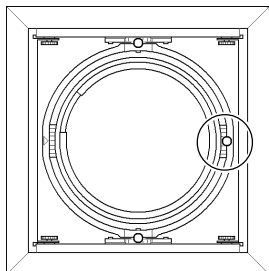

Suitable for use indoors  
Geeignet für Innenanwendung  
Pour un usage interne  
Adecuada para uso en interiores  
Geschikt voor gebruik binnen  
Lämplig för inomhusbruk



Replace any cracked protective shield.

Dieses symbol bedeutet, dass defekte Schutzgläser sofort ersetzt werden müssen.

Ce symbol indique que vous devez remplacer tout verre de protection fêlé.

Este símbolo indica que hay que 'reemplazar filtros en caso de rotura o desperfectos'.

Dette symbolet indikerer at alle ødelagte (sprukne) sikkerhetsglass må skiftes.

Valaisinta el saa käyttää ilman suoja-alasia vioitunut suoja-lasi on vaihdettava uuteen ennen valaisimen käyttöön ottoa.

< Millimetres >



This Electrical Product  
MUST be recycled.



09.10

Concord

Havells Sylvania Europe LTD  
Avis Way, Newhaven East Sussex BN9 0ED UK  
www.havells-sylvania.com



© Concord Lighting Ltd.