

2050734
2050740
2051040
2051756

Disconnect from mains supply before replacing the fuse or the lamp.
Vor dem Einsetzen der Sicherung oder der Lampe Spannungsfreiheit herstellen.
Débrancher le secteur avant de remplacer le fusible ou l'ampoule.
Desconectar del suministro de la red, antes de realizar la sustitución del fusible o de la lámpara.
Voor het vervangen van lamp of zekering, eerst netspanning uitschakelen.
Koppla bort spänningen före byte av en säkring eller en lampa.

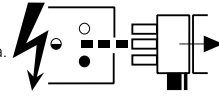

Switch Off
Abschalten
Débrancher
Desconectar
Uitschakelen
Stäng av

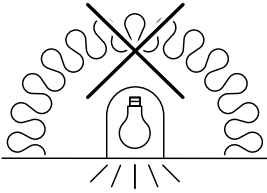

Not suitable for covering with thermally insulating material
Ne doit pas être recouvert un matériau isolant thermique

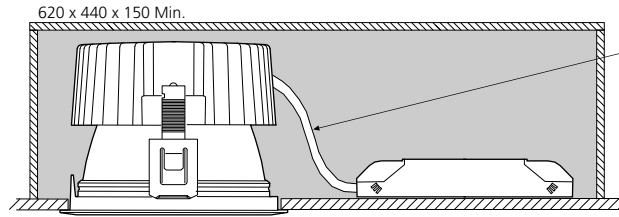

If the external cable of this luminaire is damaged, it shall be replaced by a special cable exclusively available from the manufacturer or his agent.

1

i

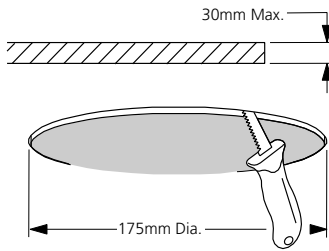

ii

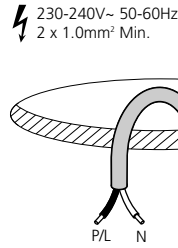

? IS1150

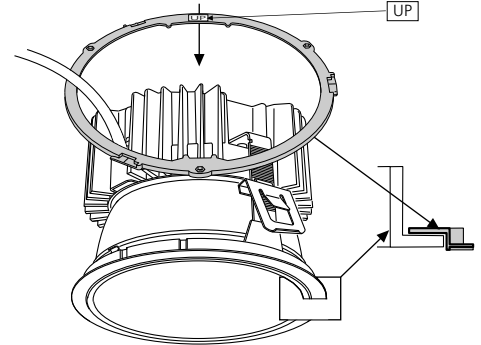

2

i

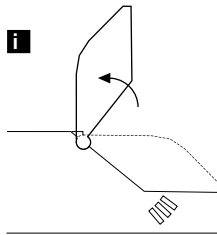

ii

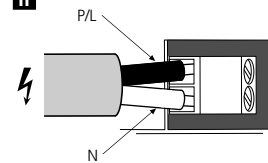

iii

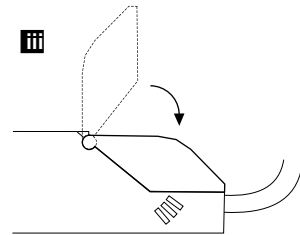

3

i

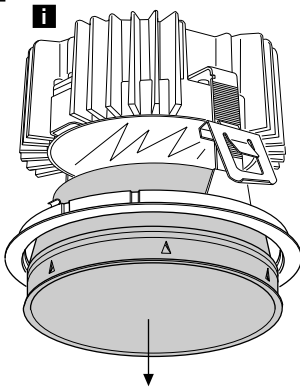

ii

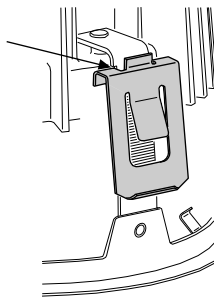

iii

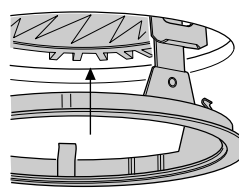

iv

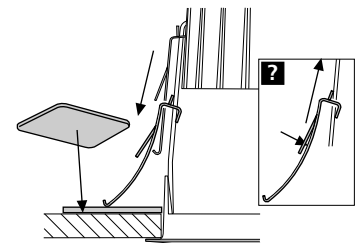

4

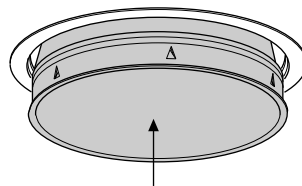

Suitable for use indoors

Geeignet für Innenanwendung

Pour un usage interne

Adecuada para uso en interiores

Geschikt voor gebruik binnen

Lämping för inomhusbruk



This Electrical Product MUST be recycled.

