

Ascent 150



IS1372D

2050734 2050740 2051040 2051756 2052624 2052630
 2052636 2052648 2056034 2056041 2056048 2056055
 2056062 2056069 2056076 2056083 2056090 2056097
 2056104 2056111 2056118 2056125 2056132 2056139

Disconnect from mains supply before replacing the fuse or the lamp.

Vor dem Einsetzen der Sicherung oder der Lampe Spannungsfreiheit herstellen.

Débrancher le secteur avant de remplacer le fusible ou l'ampoule.

Desconectar del suministro de la red, antes de realizar la sustitución del fusible o de la lámpara.

Voor het vervangen van lamp of zekering, eerst netspanning uitschakelen.

Kopla bort spänningen före byte av en säkring eller en lampa.

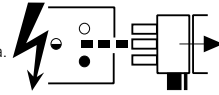

Switch Off

Abschalten

Débrancher

Desconectar

Uitschakelen

Stäng av

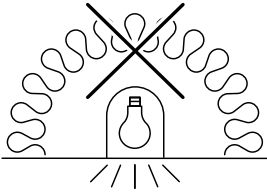

Not suitable for covering with thermally insulating material
 Ne doit pas être recouvert un matériau isolant thermique

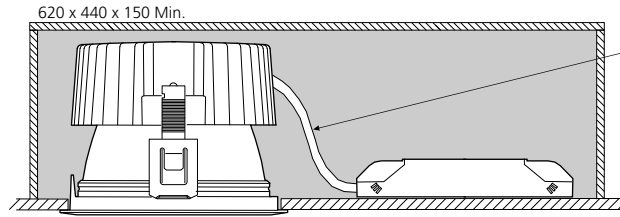

620 x 440 x 150 Min.

If the external cable of this luminaire is damaged, it shall be replaced by a special cable exclusively available from the manufacturer or his agent.

1

i

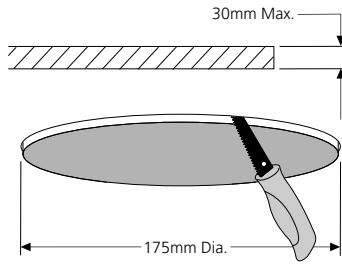

ii

230-240V~ 50-60Hz
 2 x 1.0mm² Min.

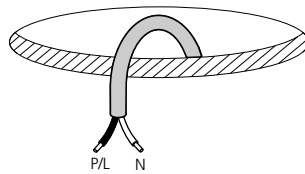

? IS1150

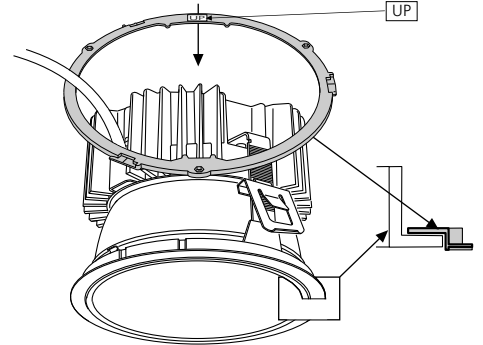

2

i

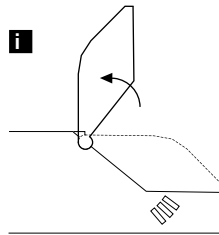

ii

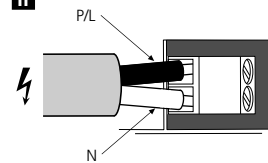

iii

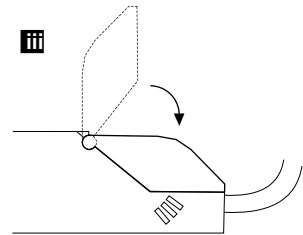

3

i

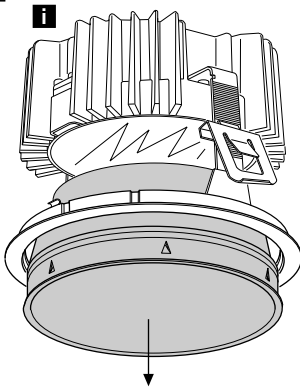

ii

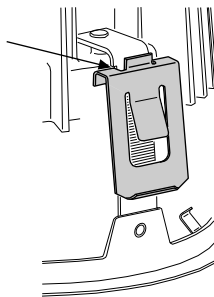

iii

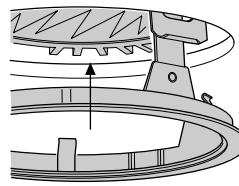

iv

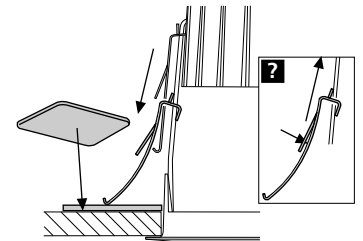

4

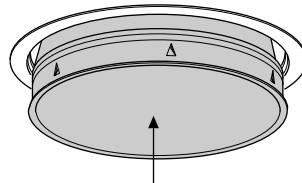

Suitable for use indoors

Geeignet für Innenanwendung

Pour un usage interne

Adecuada para uso en interiores

Geschikt voor gebruik binnen

Lämplig för inomhusbruk



This Electrical Product MUST be recycled.



Concord

Havells Sylvania Europe LTD
 Avis Way, Newhaven East Sussex BN9 0ED UK
 www.havells-sylvania.com

EM539002 FM01687
 © Concord Lighting Limited 09.12