

Mini Continuum LED

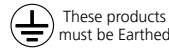

IS1507

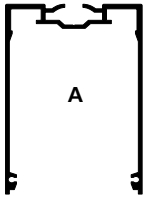

2054872-2054877
2054881-2054886
2054890-2054895
2054899-2054904
2055080-2055084
2055088-2055093
2055097-2055102
2055106-2055111

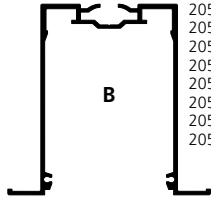

2054878-2054880
2054887-2054889
2054896-2054898
2054905-2055079
2055085-2055087
2055094-2055096
2055103-2055105
2055112-2055114

Isolate from the mains supply before any maintenance.

Vor Wartungsarbeiten von der Netzspannung trennen.

Veuillez isoler le luminaire du courant avant toute maintenance.

Aislar de la red eléctrica antes de cualquier operación de mantenimiento.

Koppel het toestel af van de netspanning voor elk onderhoud.

Isolera från elnätet innan något underhåll.

Suitable for use indoors

Geeignet für Innenanwendung

Pour un usage interne

Adecuada para uso en interiores

Geschikt voor gebruik binnen

Lämplig för inomhusbruk

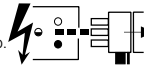

Switch Off

Abschalten

Débrancher

Desconectar

Uitschakelen

Stäng av

A

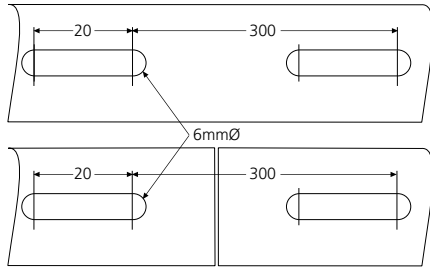
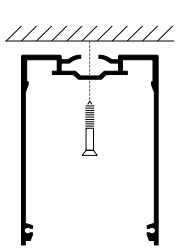

2035020
2035022-3
2035025-6



2035015-6
2035018
2035031

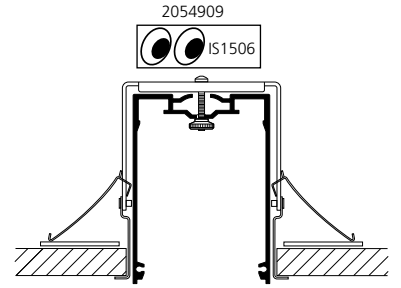
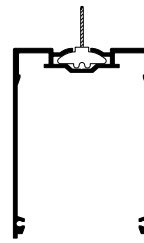
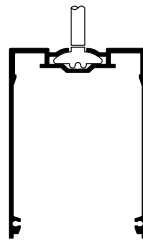

B

2035020
2035022-3
2035025-6



2035015-6
2035018
2035031

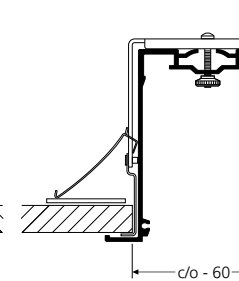
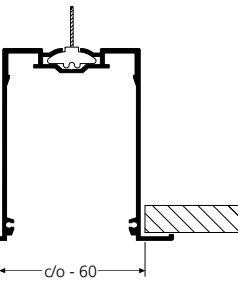
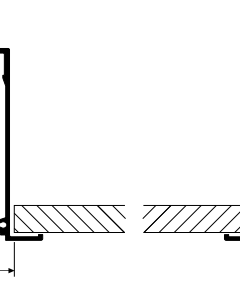
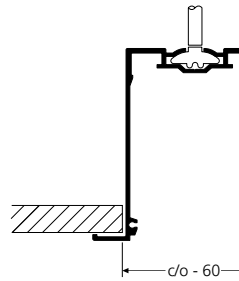

A

2054910
2054911

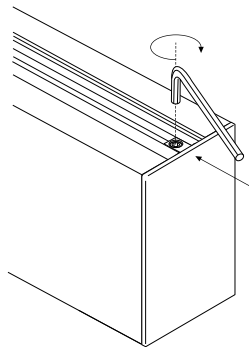
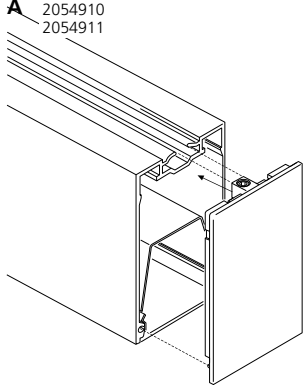

B

2054912
2054913

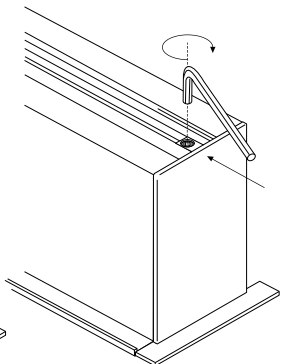
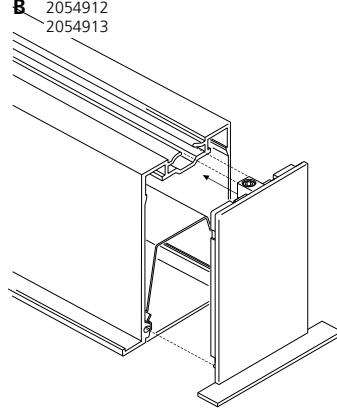

A & B 2054914

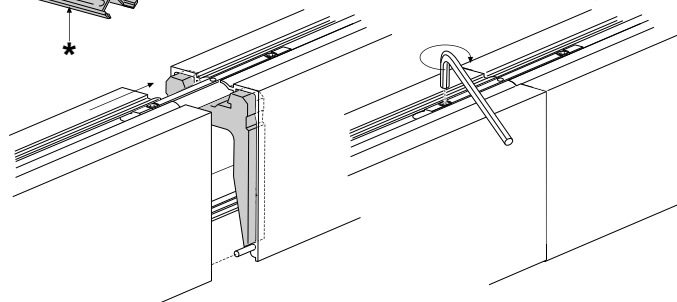
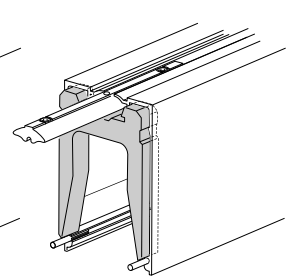
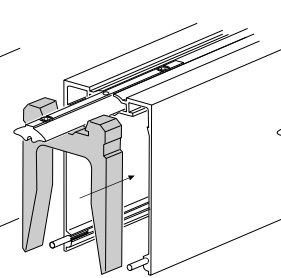
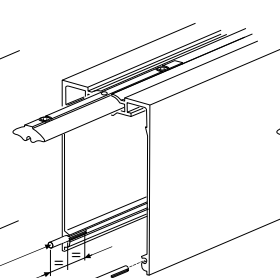
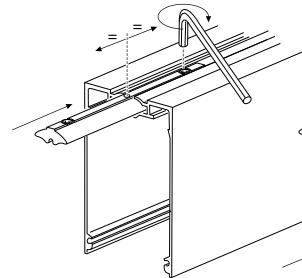
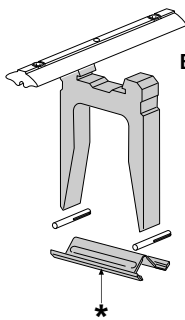

* A & B

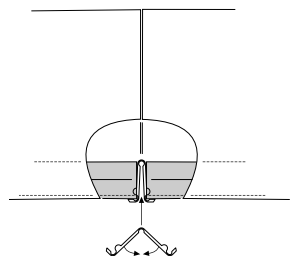
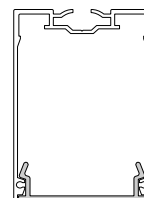
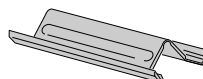

A & B
 230-240V

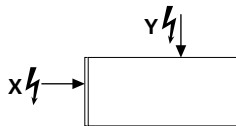

X

2054912
2054913

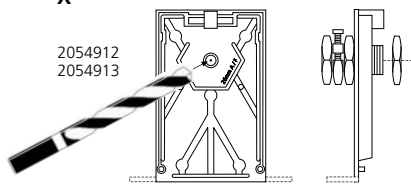

Y

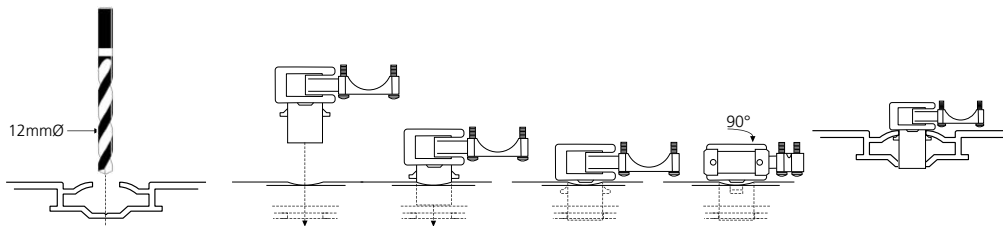

2054915
2055380

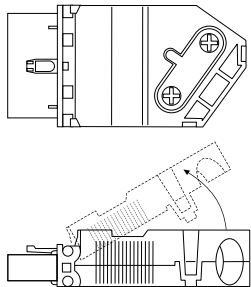

2054872-2054880
2054890-2054898

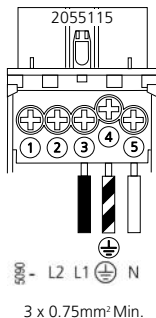

2054881-2054889
2054899-2054907

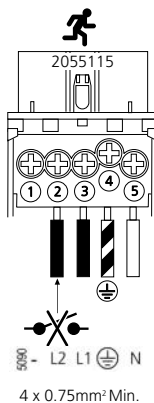

2055079-2055087
2055097-2055105

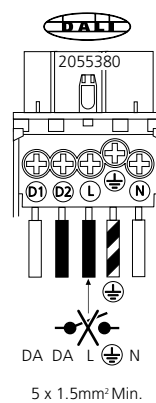

2055088-2055096
2055106-2055114

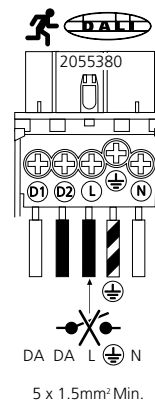

Routine Testing

Testing should be carried out in accordance with the recommendations of BS5266.

1. A monthly functional test.
2. Twice yearly, a one hour test.
3. Every three years, a full three hour duration test.

The above tests assume a three hour system.

4. Batteries should be replaced when the luminaire no longer meets the 3 hours duration performance.
5. Testing could be performed by interrupting the fixed phase supply for the test duration, during which the luminaire should remain lit.
6. Ensure that the 'LED' is 'OFF' during 'Discharge Mode', and 'ON' during 'Charging Mode'.
7. Replace faulty lamps immediately.

To assist with this testing, a test card is included below.

If the charge indicator (LED) is unlit, this signifies a fault. To increase the chance of a fault being reported between monthly tests, it is desirable that staff are made aware of the purpose of the indicator.

This module should not be modified or repaired by any person other than those nominated by the manufacturer. ANY unauthorised modifications may render the module unsafe and will invalidate our warranty and conformance to any safety standards that may apply. The company will accept no responsibility for any modified modules, or for damage caused as a result of modifications.

All details are given for guidance only and do not constitute a contract. We reserve the right to change the characteristics of products without notice.

Test Record

Type.....	Location.....	1st Year	2nd Year	3rd Year	4th Year	5th Year
Month	Test					
	1. Functional					
	2. Functional					
	3. Functional					
	4. Functional					
	5. Functional					
	6. Functional					
	7. Functional					
	8. Functional					
	9. One Hour					
	Three Hour					
	10. Functional					
	11. Function					
	12. Functional					

Replace any cracked protective shield.
 Dieses symbol bedeutet, dass defekte schutzgläser sofort ersetzt werden müssen.

Ce symbole indique que vous devez remplacer tout verre de protection fêlé.
 Este simbolo indica que hay que reemplazar filtros en caso de rotura o desperfectos.

Dette symbolet indikerer at alle delagte (sprukne) sikkerhetglass må skiftes.
 Valaisinta el saa käyttää ilman suojalasia vioittunut suojalasi on vaihdettava uuteen ennen valaisimen käyttöön ottoa.

◀ millimetres ▶ This Electrical Product MUST be recycled.

Concord

Avis Way Newhaven East Sussex BN9 0ED
 T 0870 606 2030 F 01273 512 688 email: information@concordmarlin.com
 www.havells-sylvania.com

© Concord Lighting Limited
 09.12