

# Lytepanel Recessed

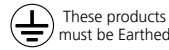

IS1513B

- 2054840-47 - 600x600
- 2054848-55 - 625x625
- 2054856-63 - 1200x300
- 2054864-71 - 1250x312

**Isolate from the mains supply before any maintenance.**

Vor Wartungsarbeiten von der Netzspannung trennen.

**Veillez isoler le luminaire du courant avant toute maintenance.**

Aislar de la red eléctrica antes de cualquier operación de mantenimiento.

**Koppel het toestel af van de netspanning voor elk onderhoud.**  
Isolera från elnätet innan något underhåll.

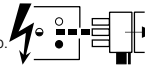

**Switch Off**  
Abschalten  
**Débrancher**  
Desconectar  
**Uitschakelen**  
Stäng av

Not suitable for covering with thermally insulating material  
Ne doit pas être recouvert un matériau isolant thermique

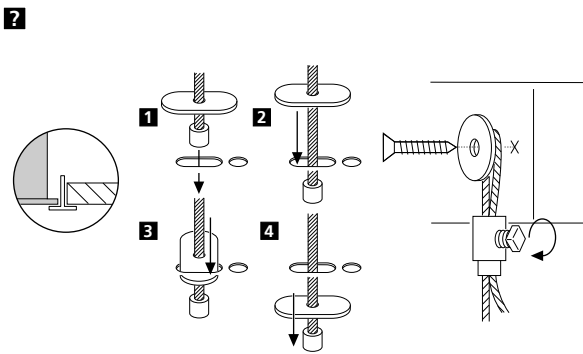
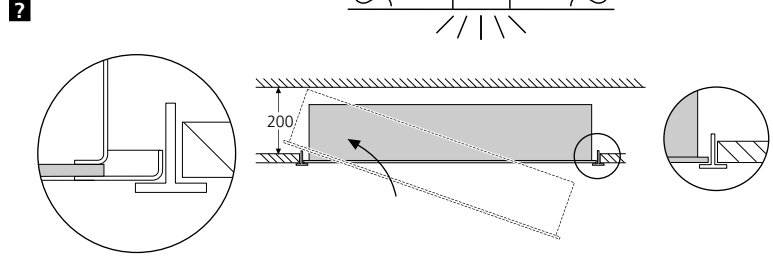
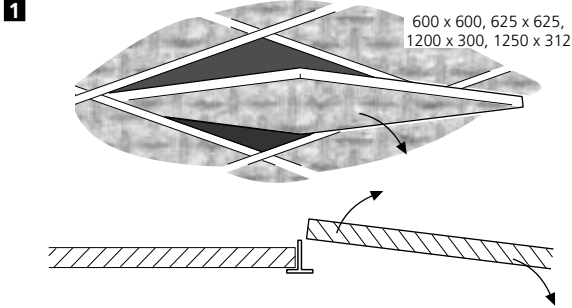
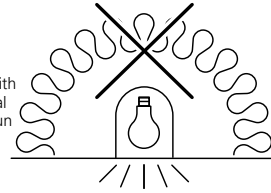

**2** ⚡ 230-240V~ 0.75mm² Min. □

- 2054840
- 2054844
- 2054848
- 2054852
- 2054856
- 2054860
- 2054864
- 2054868

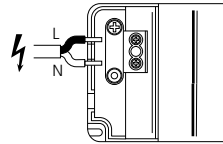

**2** ⚡ 230-240V~ 0.75mm² Min. + DALI □

- 2054842
- 2054846
- 2054850
- 2054854
- 2054858
- 2054862
- 2054866
- 5054870

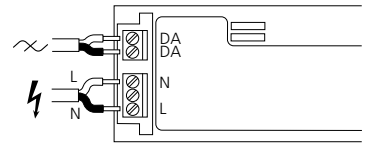

**2** ⚡ 230-240V~ 0.75mm² Min. + ⚡

- 2054841
- 2054845
- 2054849
- 2054853
- 2054857
- 2054861
- 2054865
- 2054869

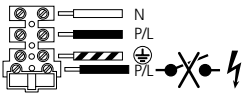

**2** ⚡ 230-240V~ 0.75mm² Min. + ⚡ + DALI

- 2054843
- 2054847
- 2054851
- 2054855
- 2054859
- 2054863
- 2054867
- 2054871

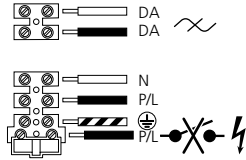

**2** ⚡

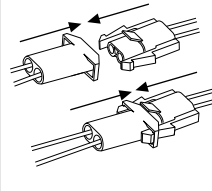

**3**

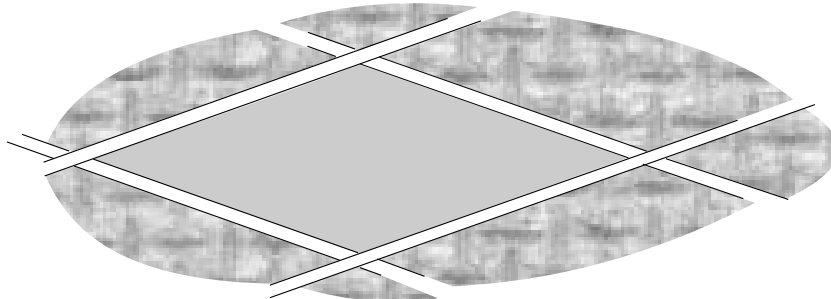
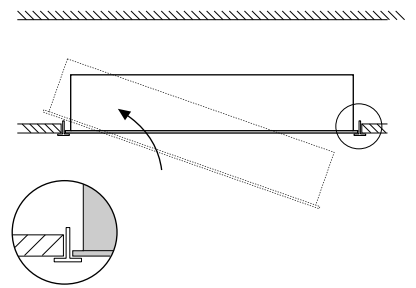

### Routine Testing

Testing should be carried out in accordance with the recommendations of BS5266.

1. A monthly functional test.
  2. Twice yearly, a one hour test.
  3. Every three years, a full three hour duration test.
- The above tests assume a three hour system.
4. Batteries should be replaced when the luminaire no longer meets the 3 hours duration performance.
  5. Testing could be performed by interrupting the fixed phase supply for the test duration, during which the luminaire should remain lit.
  6. Ensure that the 'LED' is 'OFF' during 'Discharge Mode', and 'ON' during 'Charging Mode'.
  7. Replace faulty lamps immediately.

To assist with this testing, a test card is included below.

If the charge indicator (LED) is unlit, this signifies a fault. To increase the chance of a fault being reported between monthly tests, it is desirable that staff are made aware of the purpose of the indicator.

This module should not be modified or repaired by any person other than those nominated by the manufacturer. ANY unauthorised modifications may render the module unsafe and will invalidate our warranty and conformance to any safety standards that may apply. The company will accept no responsibility for any modified modules, or for damage caused as a result of modifications.

All details are given for guidance only and do not constitute a contract. We reserve the right to change the characteristics of products without notice.

### Test Record

Type:.....	Location.....					
Month	Test	1st Year	2nd Year	3rd Year	4th Year	5th Year
	1. Functional					
	2. Functional					
	3. Functional					
	4. Functional					
	5. Functional					
	6. Functional					
	7. Functional					
	8. Functional					
	9. One Hour					
	Three Hour					
	10. Functional					
	11. Function					
	12. Funtional					

### Suitable for use indoors

Geeignet für Innenanwendung

### Pour un usage interne

Adecuada para uso en interiores

### Geschikt voor gebruik binnen

Lämplig för inomhusbruk



### Replace any cracked protective shield.

Dieses symbol bedeutet, dass defekte schutzgläser sofort ersetzt werden müssen.

**Ce symbole indique que vous devez remplacer tout verre de protection fêlé.**

Este simbolo indica que hay que 'reemplazar filtros en caso de rotura o desperfectos'.

**Dette symbolet indikerer at alle ødelagte (sprukne) sikkerhetglass må skiftes.**

Valaisinta el saa käyttää ilman suojalasia vioitunut suojalasi on vaihdettava uuteen ennen valaisimen käyttöön ottoa.



This Electrical Product  
MUST be recycled.



# Concord

Havells Sylvania Europe LTD  
Avis Way, Newhaven East Sussex BN9 0ED UK  
www.havells-sylvania.com



EM539002 FM01687  
© Concord Lighting Limited 03.12