

1200 x 300
2055229
2055230
2055231
2055232

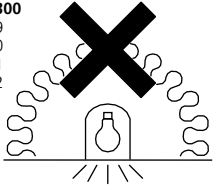

Not suitable for covering with thermally insulating material
Ne doit pas être recouvert un matériau isolant thermique

Disconnect from mains supply before replacing the fuse or the lamp.
Vor dem Einsetzen der Sicherung oder der Lampe Spannungsfreiheit herstellen.
Débrancher le secteur avant de remplacer le fusible ou l'ampoule.
Desconectar del suministro de la red, antes de realizar la sustitución del fusible o de la lámpara.
Voor het vervangen van lamp of zekering, eerst netspanning uitschakelen.
Koppla bort spänningen före byte av en säkring eller en lampa.

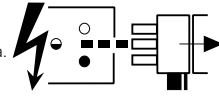

Switch Off
Abschalten
Débrancher
Desconectar
Uitschakelen
Stäng av

?

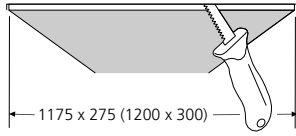

?

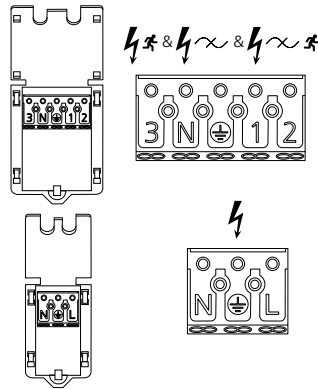

2 ⚡ 230-240V~ 1.0mm² Min.
2055229

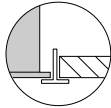
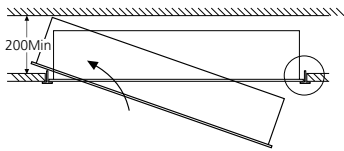
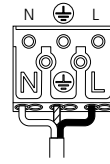

2047754

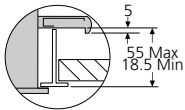
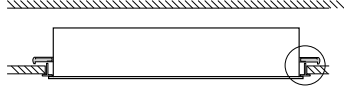

⚡ 2055230

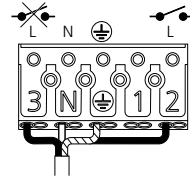

1

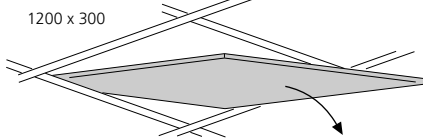

2047754

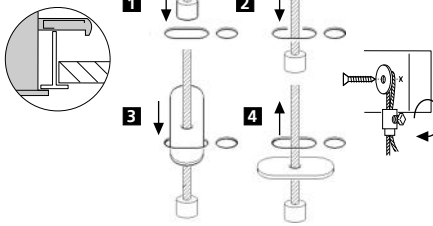

⚡ 2055231

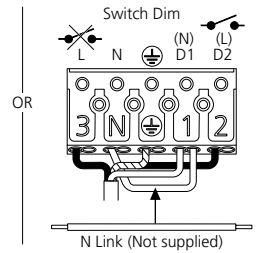
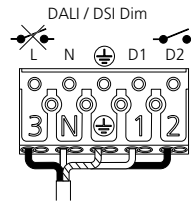

⚡

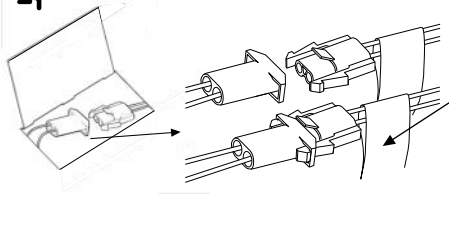

COMMISSIONING DATE	JAN	FEB	MAR	APR
	2010	2011	2012	2013
2014	2015	2016	2017	
2018	2019	2020	2021	

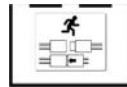

⚡ 2055232

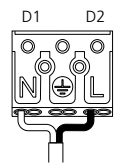
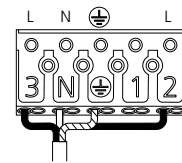

3

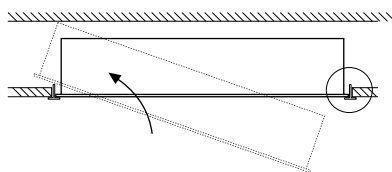
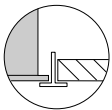

2047754

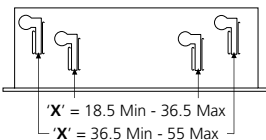
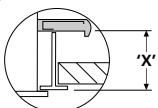

1

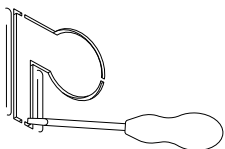

2

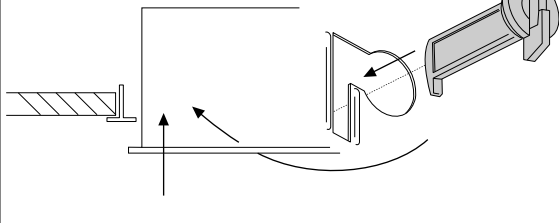

3

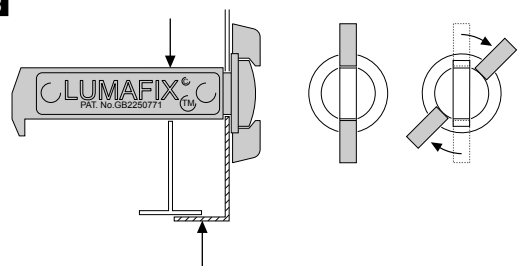

2041206

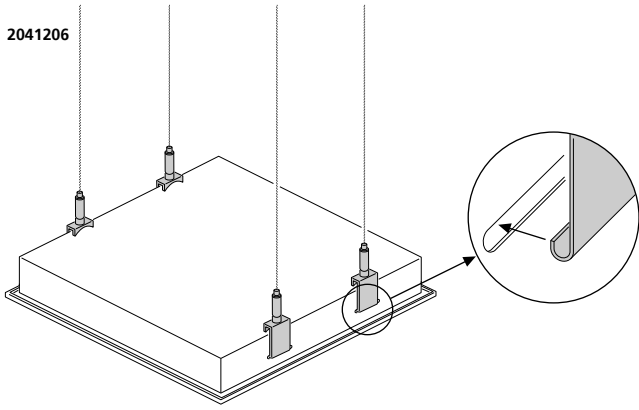

1

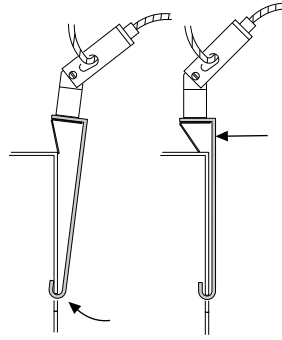

2

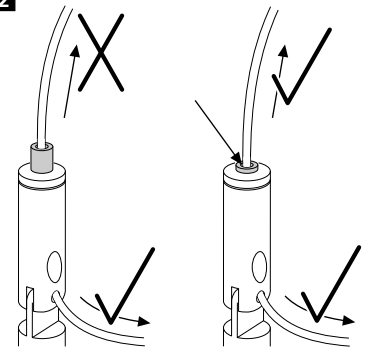

4

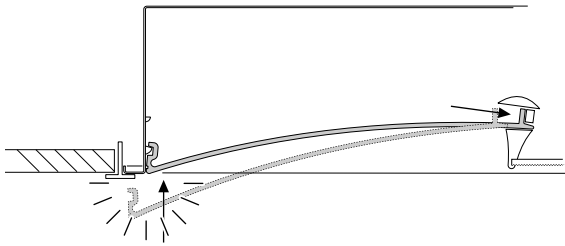

?

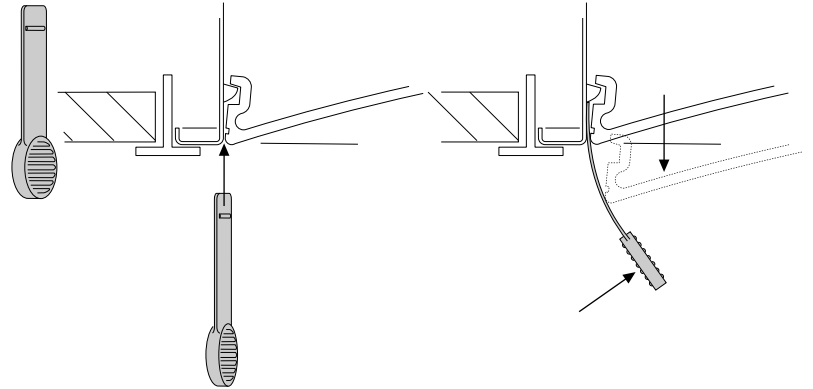

Routine Testing

Testing should be carried out in accordance with the recommendations of BS5266.

1. A monthly functional test.
 2. Twice yearly, a one hour test.
 3. Every three years, a full three hour duration test.
- The above tests assume a three hour system.
4. Batteries should be replaced when the luminaire no longer meets the 3 hours duration performance.
 5. Testing could be performed by interrupting the fixed phase supply for the test duration, during which the luminaire should remain lit.
 6. Ensure that the 'LED' is 'OFF' during 'Discharge Mode', and 'ON' during 'Charging Mode'.
 7. Replace faulty lamps immediately.

To assist with this testing, a test card is included below.

If the charge indicator (LED) is unlit, this signifies a fault. To increase the chance of a fault being reported between monthly tests, it is desirable that staff are made aware of the purpose of the indicator.

This module should not be modified or repaired by any person other than those nominated by the manufacturer. ANY unauthorised modifications may render the module unsafe and will invalidate our warranty and conformance to any safety standards that may apply. The company will accept no responsibility for any modified modules, or for damage caused as a result of modifications.

All details are given for guidance only and do not constitute a contract. We reserve the right to change the characteristics of products without notice.

Test Record

Type:.....	Location.....	1st Year	2nd Year	3rd Year	4th Year	5th Year
Month	Test					
	1. Functional					
	2. Functional					
	3. Functional					
	4. Functional					
	5. Functional					
	6. Functional					
	7. Functional					
	8. Functional					
	9. One Hour					
	Three Hour					
	10. Functional					
	11. Function					
	12. Functional					

Suitable for use indoors

Geeignet für Innenanwendung

Pour un usage interne

Adecuada para uso en interiores

Geschikt voor gebruik binnen

Lämplig för inomhusbruk

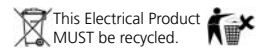

Concord

Havells Sylvania Europe LTD
 Avis Way, Newhaven East Sussex BN9 0ED UK
 www.havells-sylvania.com



© Concord Lighting Limited
 03.13