

# Ascent 150 LED EMPRO



These products must be Earthed

IS1534

2056040 2056047 2056054 2056061 2056068 2056075  
 2056082 2056089 2056096 2056103 2056110 2056117  
 2056124 2056131 2056138 2056145  
 2056152-2056159

**Isolate from the mains supply before any maintenance.**

Vor Wartungsarbeiten von der Netzspannung trennen.

**Veillez isoler le luminaire du courant avant toute maintenance.**

Aislar de la red eléctrica antes de cualquier operación de mantenimiento.

**Koppel het toestel af van de netspanning voor elk onderhoud.**

Isolera från elnätet innan något underhåll.

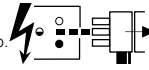

**Switch Off**

Abschalten

**Débrancher**

Desconectar

**Uitschakelen**

Stång av

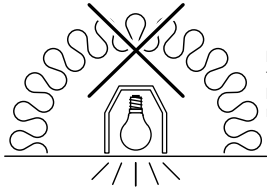

Not suitable for covering with thermally insulating material  
 Ne doit pas être recouvert un matériau isolant thermique

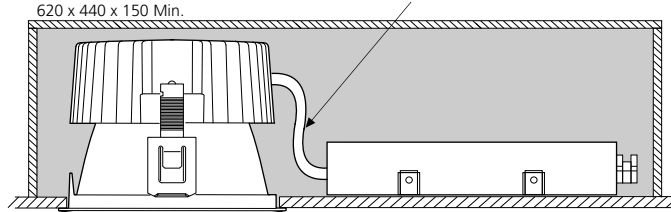

If the external cable of this luminaire is damaged, it shall be replaced by a special cable exclusively available from the manufacturer or his agent.

**1**

**i**

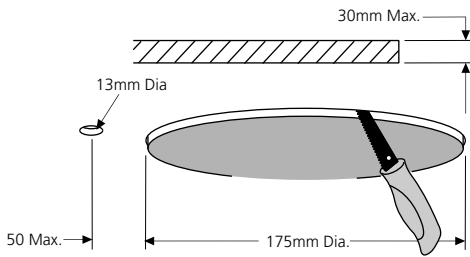

**ii**

230-240V~ 50-60Hz  
 4 x 1.0mm<sup>2</sup> Min.

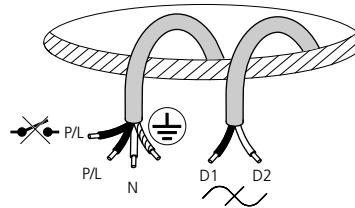

**2**

IS1150

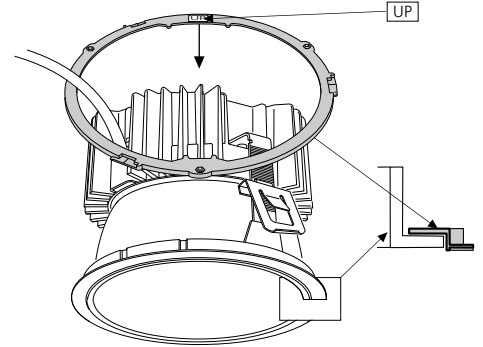

**2**

**i**

+ DALI + PRO

1A

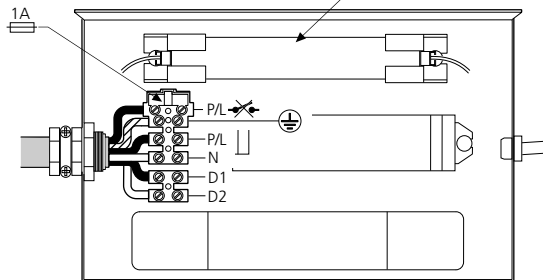

**ii**

COMMISSIONING DATE	JAN	FEB	MAR	APR
	MAY	JUN	JUL	AUG
	SEP	OCT	NOV	DEC
	2010	2011	2012	2013
	2014	2015	2016	2017
	2018	2019	2020	2021

**iii**

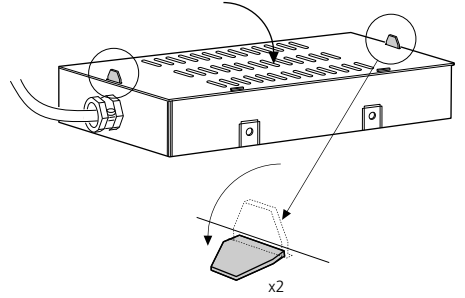

**3**

**i**

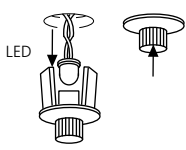

**ii**

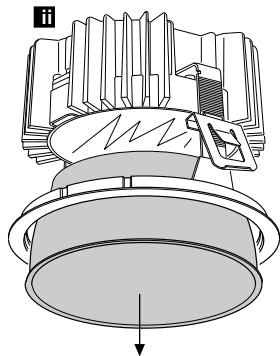

**iii**

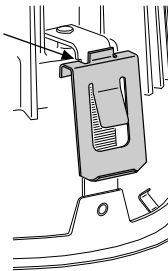

**iv**

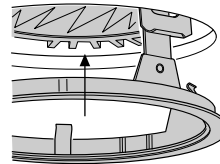

**v**

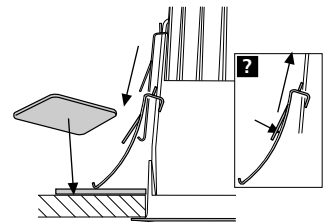

**4**

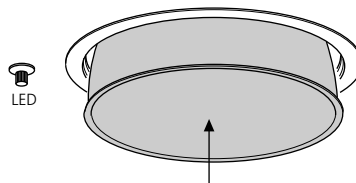

**Routine Testing**

Testing should be carried out in accordance with the recommendations of BS5266.

- 1. A monthly functional test.
- 2. Twice yearly, a one hour test.
- 3. Every three years, a full three hour duration test.

The above tests assume a three hour system.

4. Batteries should be replaced when the luminaire no longer meets the 3 hours duration performance.

5. Testing could be performed by interrupting the fixed phase supply for the test duration, during which the luminaire should remain lit.

6. Ensure that the 'LED' is 'OFF' during 'Discharge Mode', and 'ON' during 'Charging Mode'.

7. Replace faulty lamps immediately.

To assist with this testing, a test card is included below.

If the charge indicator (LED) is unlit, this signifies a fault. To increase the chance of a fault being reported between monthly tests, it is desirable that staff are made aware of the purpose of the indicator.

This module should not be modified or repaired by any person other than those nominated by the manufacturer. ANY unauthorised modifications may render the module unsafe and will invalidate our warranty and conformance to any safety standards that may apply. The company will accept no responsibility for any modified modules, or for damage caused as a result of modifications.

All details are given for guidance only and do not constitute a contract. We reserve the right to change the characteristics of products without notice.

**Test Record**

Type:.....	Location.....					
Month	Test	1st Year	2nd Year	3rd Year	4th Year	5th Year
	1. Functional					
	2. Functional					
	3. Functional					
	4. Functional					
	5. Functional					
	6. Functional					
	7. Functional					
	8. Functional					
	9. One Hour					
	Three Hour					
	10. Functional					
	11. Function					
	12. Funtional					

**Suitable for use indoors**

Geeignet für Innenanwendung

Pour un usage interne

Adecuada para uso en interiores

Geschildt voor gebruik binnen

Lämpilg för inomhusbruk



**Concord**

Havells Sylvania Europe LTD  
Avis Way, Newhaven East Sussex BN9 OED UK  
www.havells-sylvania.com



© Concord Lighting Limited 08.13