

Installation Instructions for: **S50FIXWH S50FIXCH S50FIXB**

9134795
9134801
9134810

Follow these instructions carefully to ensure safe and reliable operation.

SAFETY

Follow the appropriate wiring regulations, if in any doubt contact a qualified electrician.

Disconnect from mains supply before installation, maintenance or replacing the lamp.

Use eye protection when drilling for/cutting out the mounting hole.

This fitting is suitable for use in ambient temperatures of 25°C and should not be covered with any heat insulating material.

Airflow around the fitting should not be restricted.

Lamps reach maximum temperature rapidly. Take care when adjusting, relamping or cleaning.

We accept no responsibility for modified fittings or for the affects of cleaning solvents or the accumulation of dirt or dust.

Do not interconnect Class III fittings with Class II.

Unless otherwise marked, fittings are IP20 (ordinary), do not operate in continuously damp or corrosive environments.

Only lamps of the correct type should be used - Hi-Spot ES50 GU10 240V Max.

Not for use with dichroic lamps.

Installation Instructions

Before commencing ensure the void above the drill/cut area is free from cables and any obstructions.

Mark the position for the mounting hole. See diagram below for dimensions of cut out required.

Cut out the mounting hole.

Release the terminal block cover. Prepare and connect the cables taking note of the cable colour coding:

LIVE	L	BROWN or RED
NEUTRAL	N	BLUE or BLACK

Allow lampholder to drop down through the housing aperture.

Offer the downlight up into the mounting hole with the fixing springs held vertical.

Carefully release the clips to secure the housing into position.

Fit lamp into lampholder and push the whole assembly into the downlight aperture. Secure in place using the circular clip provided.

To avoid the clip 'slipping out' accidentally, ensure that both the notches in the clip are located into the slots in the housing.

Use firm pressure to engage trim back onto housing.

Switch on the mains supply and check that the fitting is operating correctly

Fitting(s) can be dimmed using a standard dimmer switch.

Cleaning

Switch off mains and allow to cool.

Do not use any abrasive or solvent cleaners.

Clean with a damp cloth using mild soap if necessary.

Installation Instruction Leaflet

After completion of the installation please leave this leaflet with the person responsible for lighting maintenance/end user.

240V 50W Halogen

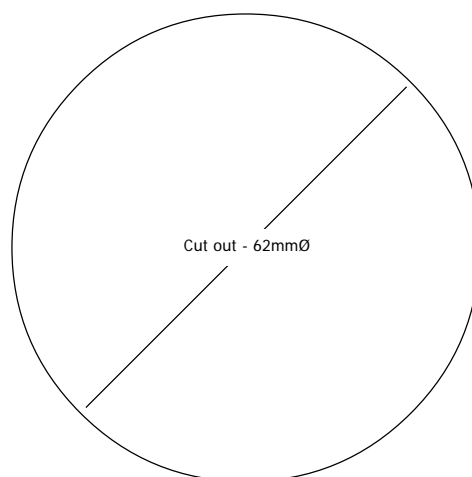
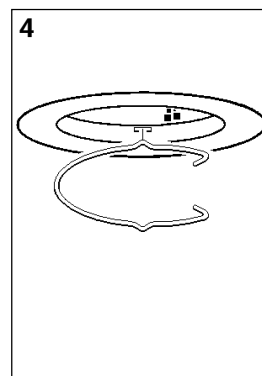
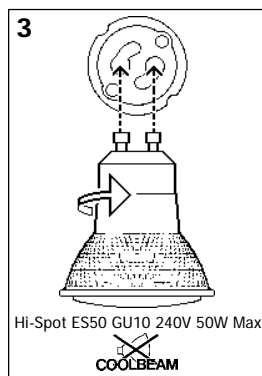
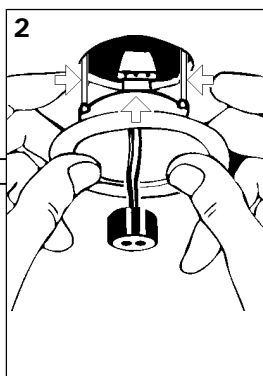
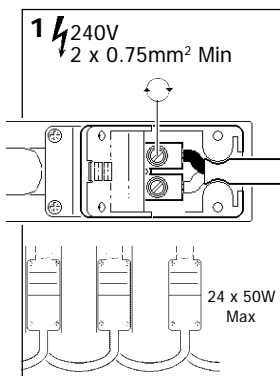
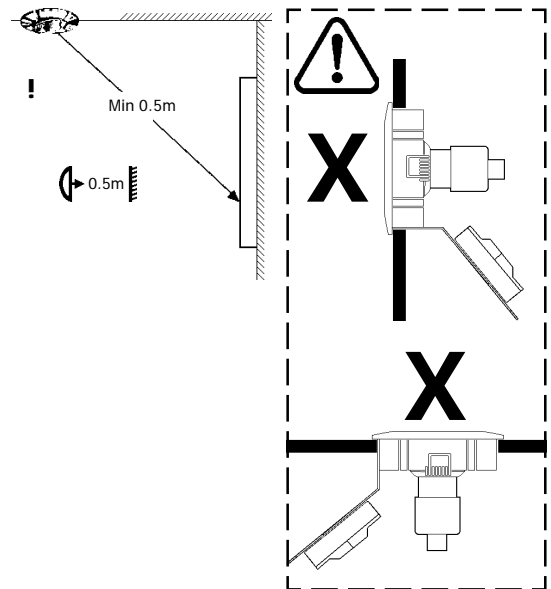
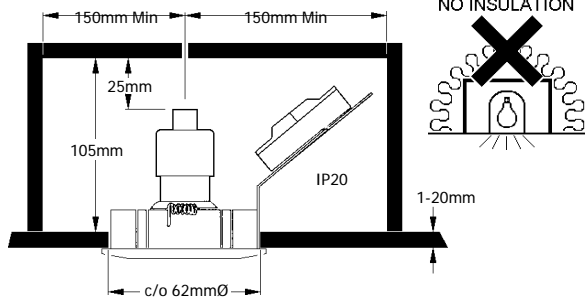

The following symbols may be found on the product or the labels:



Class 1 - This fitting must be earthed and equipotentially bonded



This fitting is suitable for mounting on normally flammable surfaces



Indicates the safest minimum distance of lamp from a normally flammable surface (0.5m)