

# LED SPOTLIGHT

LED SPOTLIGHT  
0095478 - 2.9Kg

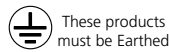

IK05

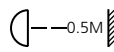

IP66



IS10055

**Isolate from the mains supply before any maintenance.**  
Vor Wartungsarbeiten von der Netzspannung trennen.  
**Veillez isoler le luminaire du courant avant toute maintenance.**  
Aislar de la red eléctrica antes de cualquier operación de mantenimiento.  
**Koppel het toestel af van de netspanning voor elk onderhoud.**  
Isolera från elnätet innan något underhåll.

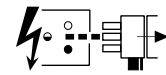

**Switch Off**  
Abschalten  
**Débrancher**  
Desconectar  
**Uitschakelen**  
Stång av

Not suitable for covering with thermally insulating material  
Ne doit pas être recouvert un matériau isolant thermique

Method of attachment of the cable or cord such that it cannot be replaced without breaking or destroying the luminaire

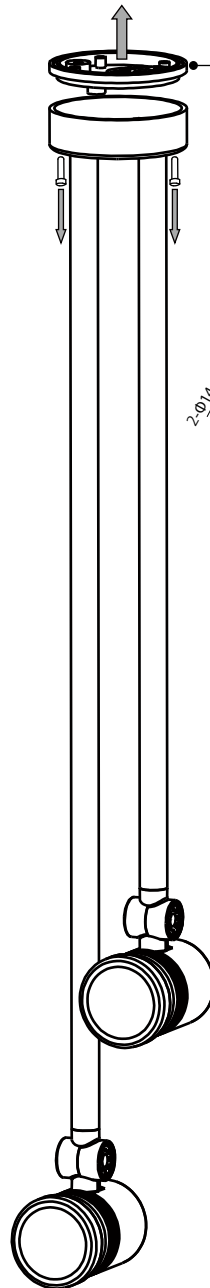
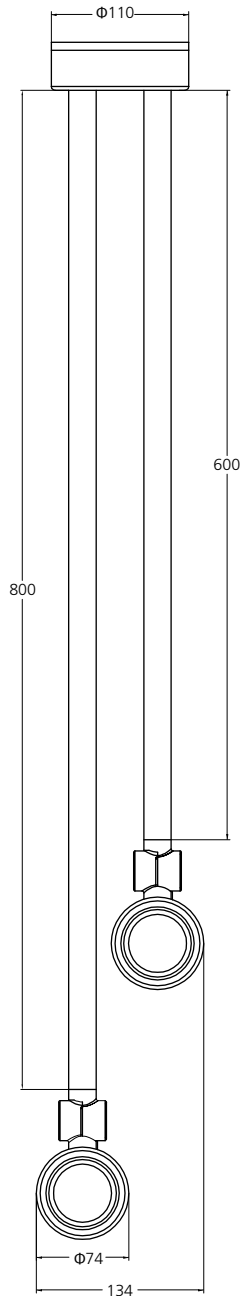
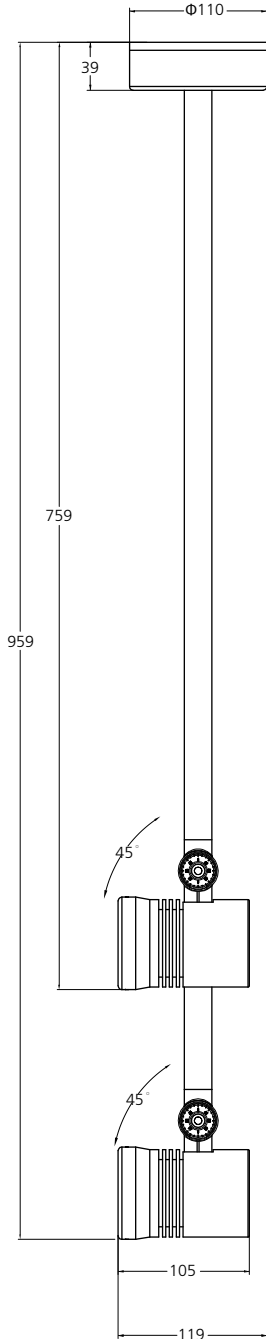

The wiring type can choose from A or B

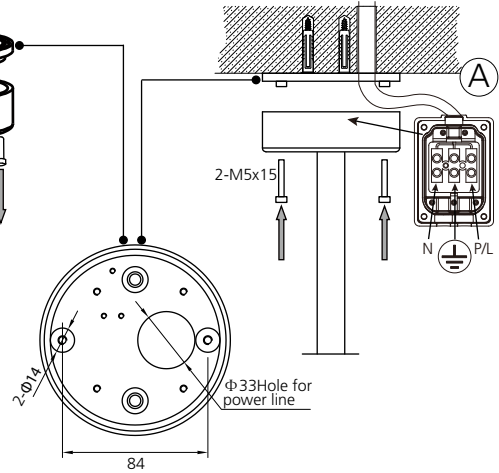

The cable goes through the ceiling

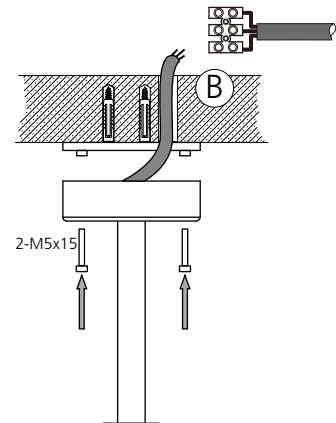

220-240VAC 50/60Hz  
H07RN-F3G Ø8 3 x 1.0mm<sup>2</sup> Min

BRN - P/L  
Y/G -   
BLU - N

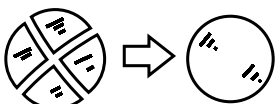
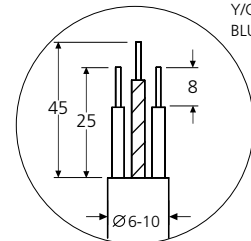

**Replace any cracked protective shield.**  
Dieses symbol bedeutet, dass defekte Schutzgläser sofort ersetzt werden müssen.  
**Ce symbole indique que vous devez remplacer tout verre de protection fêlé.**  
Este símbolo indica que hay que 'reemplazar filtros en caso de rotura o desperfectos'.  
**Dette symbolet indikerer at alle ødelagte (sprukne) sikkerhetglass må skiftes.**  
Valaisinta el saa käyttää ilman suojalasia vioitunut suojalasi on vaihdettava uuteen ennen valaisimen käyttöön ottoa.

**SYLVANIA**  
www.havells-sylvania.com

Havells Sylvania Europe LTD  
Avis Way, Newhaven East Sussex  
BN9 0ED UK  
www.havells-sylvania.com

