

0047517

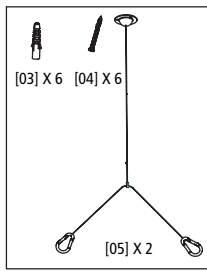

01) 1



2

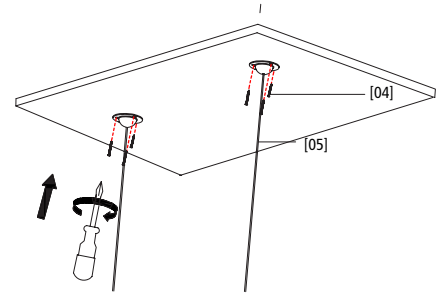
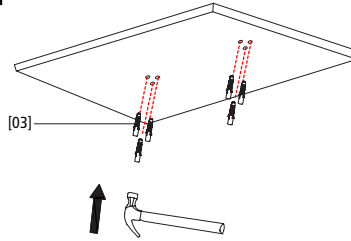

02) 1a

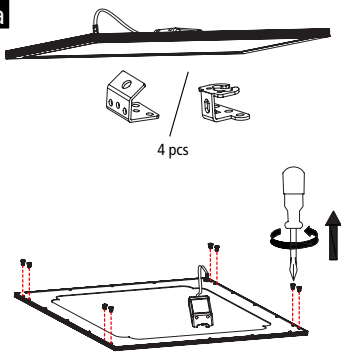

1b

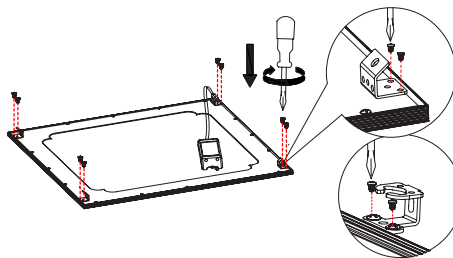

1c

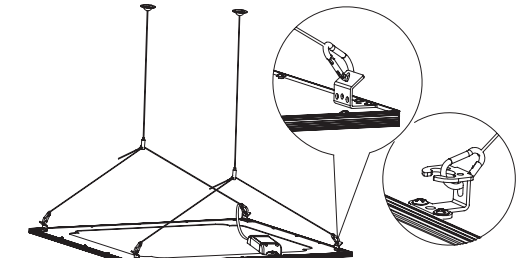

2a

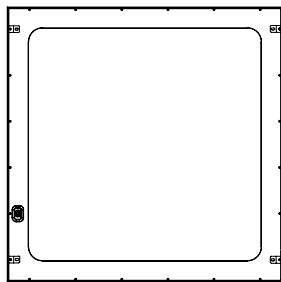

2b

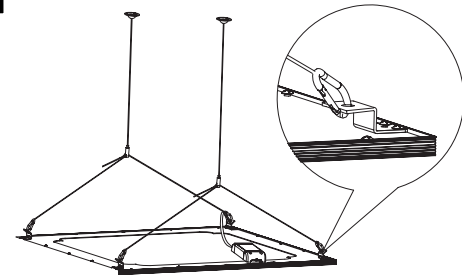

3a

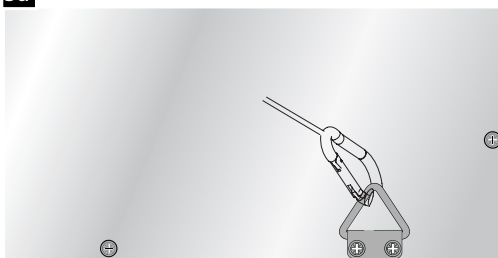

3b

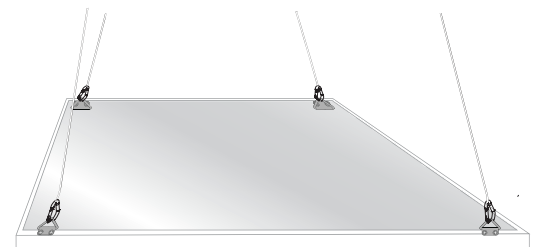

4

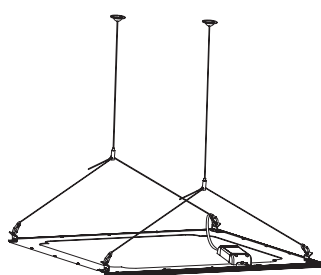

600x600 / 625x625

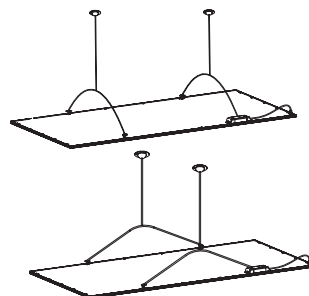

1200x300