

Follow these instructions carefully to ensure safe and reliable operation.

Safety

Follow the appropriate wiring regulations, if in any doubt contact a qualified electrician.

Disconnect mains supply before installation, maintenance or replacing the lamp.

Unless otherwise marked, fittings are IP20 (ordinary), do not operate in continuously damp or corrosive environments. If the luminaire is to be exposed to dust or moisture, the appropriate IP(XX) rated luminaire should be used.

Do not interconnect Class III fittings with Class II.

This fitting is suitable for use in ambient temperatures of 25°C and should not be covered with any heat insulating material.

Airflow around the fitting should not be restricted.

Use eye protection when drilling for/cutting out the mounting hole.

Only lamps of the correct type should be used - Hi-Spot ES50 50W GU10 240V Max.

Not for use with dichroic lamps.

Lamps reach maximum temperature rapidly. Take care when adjusting, relamping or cleaning.

We accept no responsibility for modified fittings or for the affects of cleaning solvents or the accumulation of dirt or dust.

Installation Instructions

Before commencing ensure the void above the drill/cut out area is free from cables and any obstructions.

Mark the position for the mounting hole. See diagram below for cut out dimensions.

Cut out mounting hole.

Fit terminal block mounting bracket to side of lamp housing and secure.

Allow lampholder to drop down through the lamp housing.

Fit lamp into lampholder. Secure in place using the circular clip provided.

To avoid the clip 'slipping out' accidentally, ensure that both notches in the clip are located into the slots in the housing.

Release the terminal block cover.

Prepare and connect the cables taking note of the cable colour coding:

LIVE	L	BROWN or RED
NEUTRAL	N	BLUE or BLACK

Refit terminal block cover.

With the fixing springs held vertical, push housing through mounting.

Carefully release fixing springs to secure the housing into position.

Switch on the mains supply and check that the fitting is operating correctly

Fitting(s) can be dimmed using a standard dimmer switch.

Cleaning

Switch off mains and allow to cool.

Do not use any abrasive or solvent cleaners.

Clean with a damp cloth using mild soap if necessary.

Installation Instruction Leaflet

After completion of the installation please leave this leaflet with the person responsible for lighting maintenance/end user.

240V 75W Halogen

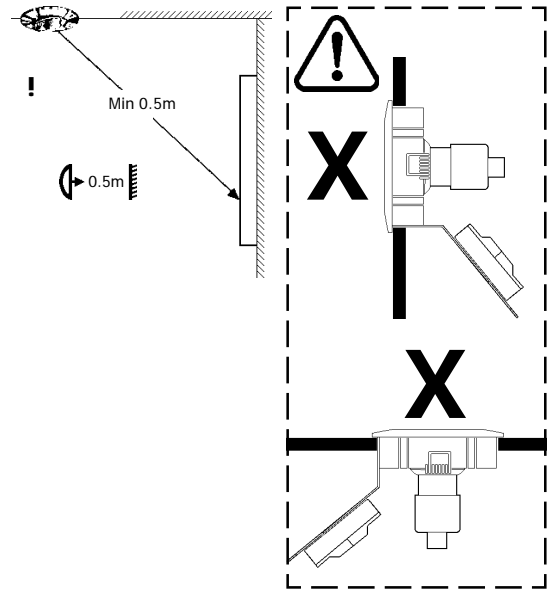
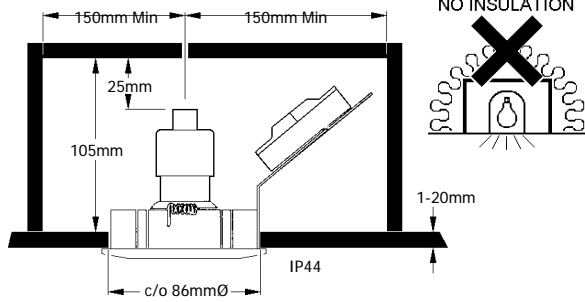

F - This fitting is suitable for mounting on normally flammable surfaces
! - Indicates the safest minimum distance of the lamp from a flammable surface

