

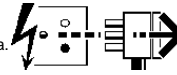

Disconnect from mains supply before replacing the fuse or the lamp.
 Vor dem Einsetzen der Sicherung oder der Lampe Spannungsfreiheit herstellen.
Débrancher le secteur avant de remplacer le fusible ou l'ampoule.
 Desconectar del suministro de la red, antes de realizar la sustitución del fusible o de la lámpara.
Voor het vervangen van lamp of zekering, eerst netspanning uitschakelen.
 Koppla bort spänningen före byte av en säkring eller en lampa.

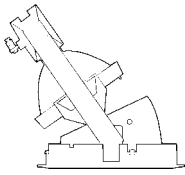

Switch Off
 Abschalten
Débrancher
 Desconectar
Uitschakelen
 Stäng av



Adjustable Accessory Downlight
 2035293 2035294 2035295
 2035320 2035321 2035322
 2035346 2035347 2035348

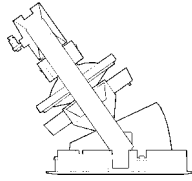

Adjustable Accessory Downlight
 2035353 2035354 2035355

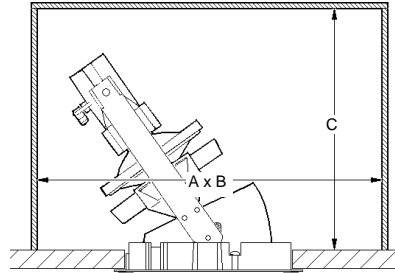

A = 500
 B = 350
 C = 245

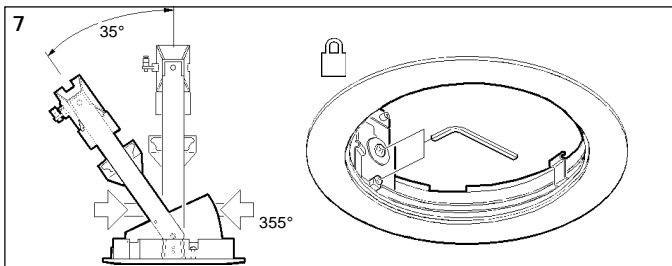
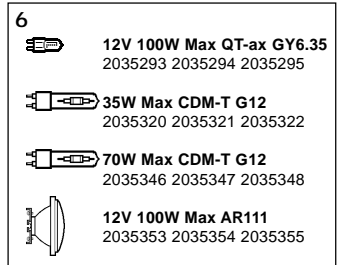
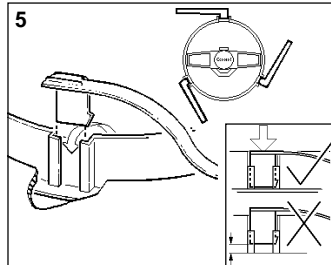
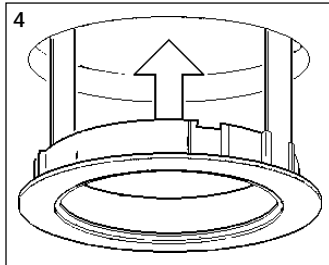
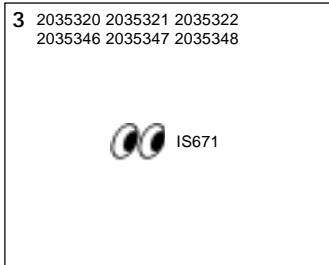
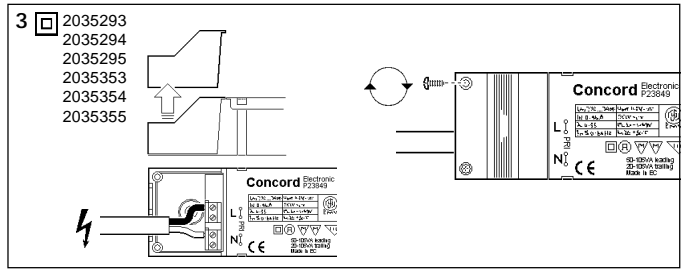
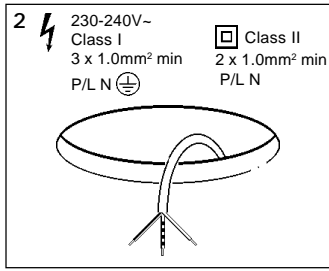
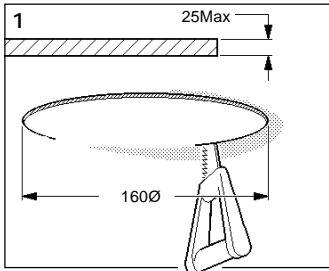

	Honeycomb	UV Filter	Daylight	Dydium Pink	Red	Amber
2027240 Honeycomb	●	●	●	●	●	●
2027241 UV Filter	●	●	●	●	●	●
2027246 Daylight	●	●	●	●	●	●
2032127 Dydimium Pink	●	●	●	●	●	●
2027244 Red	●	●	●	●	●	●
2027245 Amber	●	●	●	●	●	●

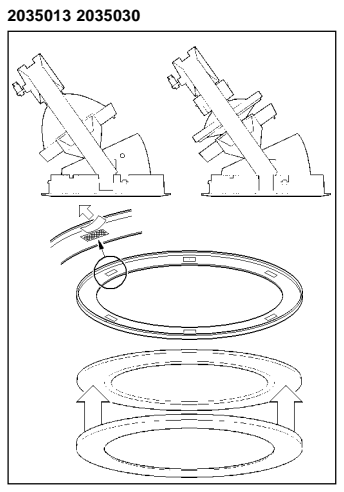
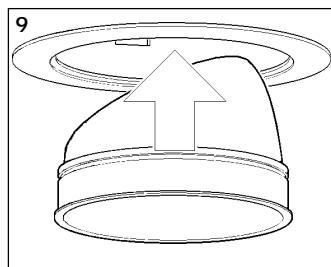
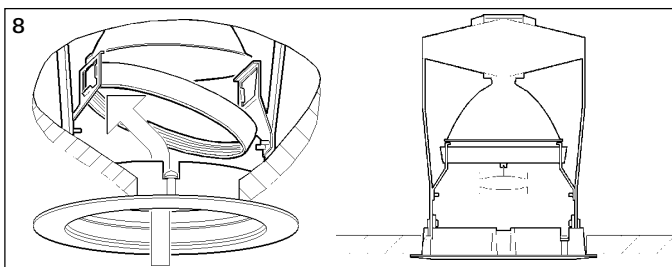
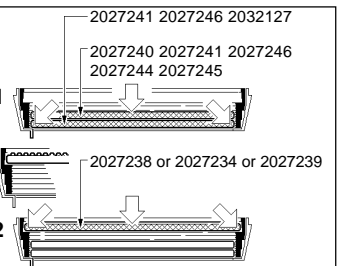

Suitable for use indoors
 Geeignet für Innenanwendung
Pour un usage interne
 Adecuada para uso en interiores
Geschikt voor gebruik binnen
 Lämplig för inomhusbruk



Replace any cracked protective shield.

Dieses symbol bedeutet, dass defekte Schutzgläser sofort ersetzt werden müssen.
Ce symbole indique que vous devez remplacer tout verre de protection fêlé.

Este símbolo indica que hay que reemplazar filtros en caso de rotura o desperfectos'.



Dette symbolet indikerer at alle ødelagte (sprukne) sikkerhetglass må skiftes.

Valaisinta ei saa käyttää ilman suojalasias vioittunut suojalasi on vaihdettava uuteen ennen valaisimen käyttöön ottoa.

< Millimetres >



This Electrical Product MUST be recycled.



07.08

Concord

Avis Way Newhaven East Sussex BN9 0ED
 T 0870 606 2030 F 01273 512 688 email: information@concordmarlin.com

