

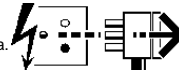

Disconnect from mains supply before replacing the fuse or the lamp.
 Vor dem Einsetzen der Sicherung oder der Lampe Spannungsfreiheit herstellen.
Débrancher le secteur avant de remplacer le fusible ou l'ampoule.
 Desconectar del suministro de la red, antes de realizar la sustitución del fusible o de la lámpara.
Voor het vervangen van lamp of zekering, eerst netspanning uitschakelen.
 Koppla bort spänningen före byte av en säkring eller en lampå.

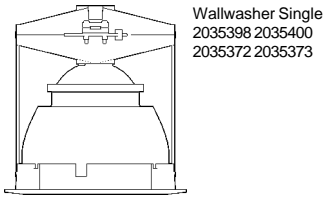

Switch Off
 Abschalten
Débrancher
 Desconectar
Uitschakelen
 Stäng av



Wallwasher Single
 2035398 2035400
 2035372 2035373

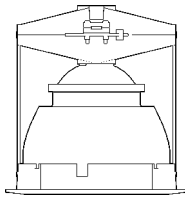

Wallwasher Double
 2035401 2035402
 2035374 2035375

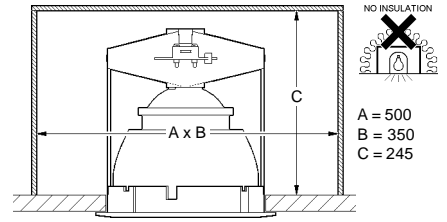
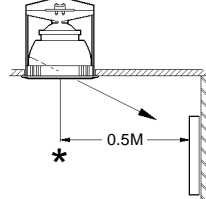

A = 500
 B = 350
 C = 245

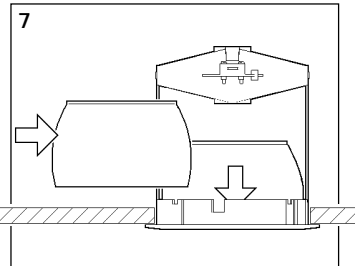
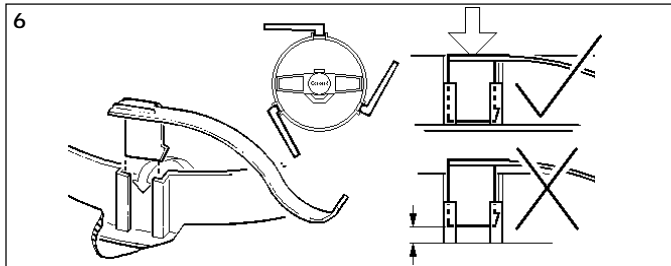
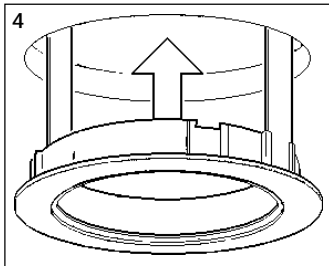
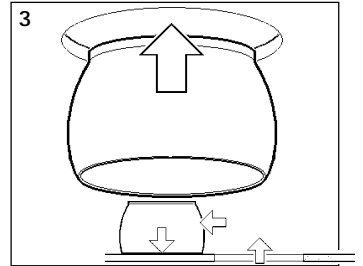
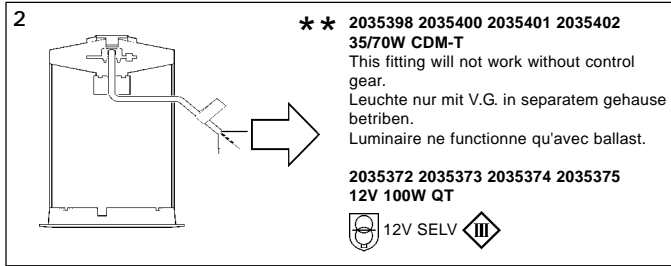
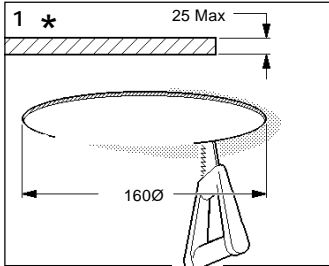

8 **12V 100W Max QT-ax GY6.35**
 2035372 2035373
 2035374 2035375

35/70W Max CDM-T G12
 2035398 2035400
 2035401 2035402

<p>Concord 35W Max CDM-T G12 230-240V~ 50Hz</p> <p> Made in UK 3752</p>	<p>Concord 70W Max CDM-T G12 230-240V~ 50Hz</p> <p> Made in UK 3751</p>
---	---

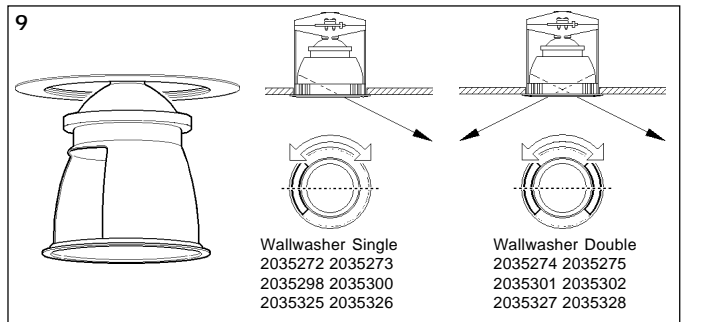

2035013 2035030

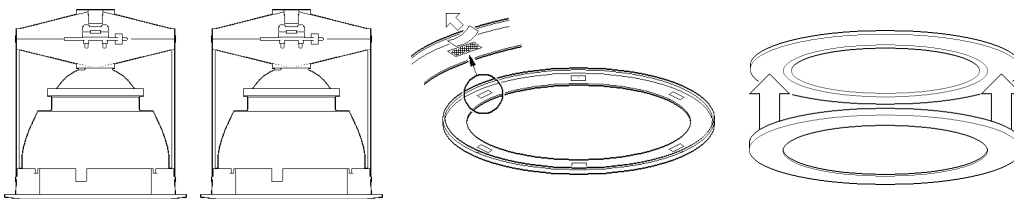

Suitable for use indoors
 Geeignet für Innenanwendung
Pour un usage interne
 Adecuada para uso en interiores
Geschikt voor gebruik binnen
 Lämplig för inomhusbruk



Replace any cracked protective shield.

Dieses symbol bedeutet, dass defekte schutzgläser sofort ersetzt werden müssen.

Ce symbole indique que vous devez remplacer tout verre de protection fêlé.

Este simbolo indica que hay que reemplazar filtros en caso de rotura o desperfectos.

Dette symbolet indikerer at alle ødelagte (sprukne) sikkerhetsglass må skiftes.

Valaisinta ei saa käyttää ilman suojalasiasa vioitunut suojalasi on vaihdettava uuteen ennen valaisimen käyttöön ottoa.

< Millimetres >



This Electrical Product **MUST be recycled.**



07.08

Concord

Avis Way Newhaven East Sussex BN9 0ED
 T 0870 606 2030 F 01273 512 688 email: information@concordmarlin.com



© Concord Lighting Ltd.