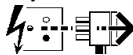

Installation Instructions for: **2636806**

## Safety

Follow these instructions carefully to ensure safe and reliable operation.

Isolate mains supply before insulation, maintenance or replacing the lamp. Follow the appropriate national wiring regulations, if in any doubt contact a qualified electrician.

 Disconnect from mains supply before installation, maintenance or replacing the lamp.

Lamps reach maximum temperatures rapidly. Take care when adjusting, relamping or cleaning.

Sylvania accepts no responsibility for modified products or for the effects of cleaning solvents or for the accumulation of dust or dirt. The products must be installed in accordance with these instructions.

FEH must not be modified. Any modification may render the product unsafe. FEH must not be covered with any heat insulating material.

Air flow around this fitting must not be restricted. Note that the minimum distance to adjacent surfaces is marked on the product label .

Take care that the safety glass is not scratched or damaged.

Replace safety glass immediately when scratched, damaged or after lamp shattering.

## Lamp disposal

Dispose of defective lamps in accordance with the manufacturers' recommendations. It is the users responsibility to ensure that the lamp disposal is carried out in accordance with local regulations.

## Cleaning

Switch off the mains supply. The fitting and lamp can quickly become hot. Ensure that both have cooled adequately before cleaning the fitting. Use only a soft damp cloth and soapy water on the outside. The reflector and lamp must only be cleaned with a soft cloth and alcohol.

## Mounting

FEH floodlights must only be mounted in a fixed horizontal position.

## Power Connection

Fixture must be connected to an individual fused circuit.

1. Use 8-13mm Dia. 3 core cable for installation
2. Remove wiring box cover.
3. Pass 3 core cable through cable entry gland 4 (gland nut, skid washer and gland ring)
4. Tighten the gland nut to make the unit water-tight and provide cable restraint.
5. Replace wiring box cover.
6. After completing the installation note the suppliers name, address and purchase date, then hand this instruction sheet to the person responsible for lighting maintenance.

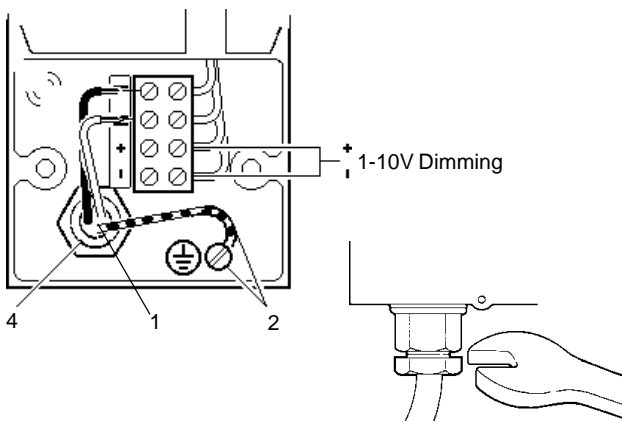

**Suitable for use indoors**  
Geeignet für Innenanwendung  
**Pour un usage interne**  
Adecuada para uso en interiores  
**Geschikt voor gebruik binnen**  
Lämplig för inomhusbruk



## Replace any cracked protective shield.

Dieses symbol bedeutet, dass defekte Schutzgläser sofort ersetzt werden müssen.

**Ce symbole indique que vous devez remplacer tout verre de protection fêlé.**

Este símbolo indica que hay que reemplazar filtros en caso de rotura o desperfectos.

**Dette symbolet indikerer at alle ødelagte (sprukne) sikkerhetsglass må skiftes.**

Valaisinta ei saa käyttää ilman suoja-alasia vioittunutta suoja-alasia on vaihdettava uuteen ennen valaisimen käyttöön ottoa.

## Mounting

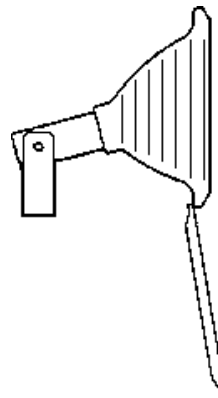
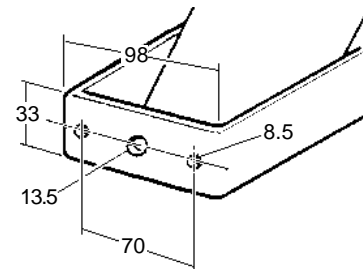
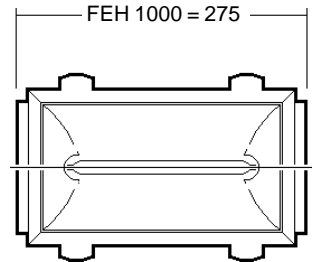
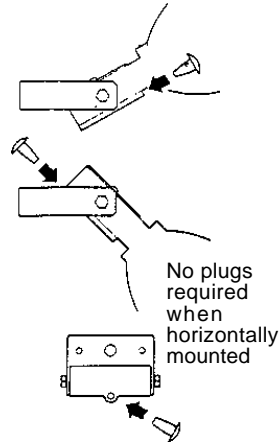
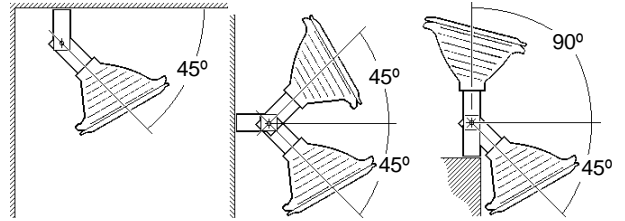

## Installation of lamp(TC-TE)

1. To open floodlight, loosen (but do not remove) the four winged nuts. Lift up the two winged nuts on the top and carefully let down the front cover.
2. Push lamps into the lampholders.
3. Re-tighten the wing nuts.

## NB

This fitting is suitable for 1-10V Dimming.

An extra cable gland has been supplied if you choose to bring the dimming cable in with an extra 2 core cable. A 16mm diameter hole will need to be made in the wiring box to accommodate this.

< Millimetres >



This Electrical Product MUST be recycled.



07.08