

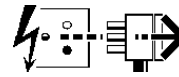

2541237

Disconnect from mains supply before replacing the fuse or the lamp.
 Vor dem Einsetzen der Sicherung oder der Lampe Spannungsfreiheit herstellen.
Débrancher le secteur avant de remplacer le fusible ou l'ampoule.
 Desconectar del suministro de la red, antes de realizar la sustitución del fusible o de la lámpara.
Voor het vervangen van lamp of zekering, eerst netspanning uitschakelen.
 Koppla bort spänningen före byte av en säkring eller en lampa.



Switch Off
 Abschalten
Couper le conector
 Desconectar
Uitschakelen
 Stäng av

Installation Instructions
IS500

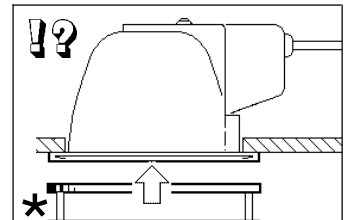
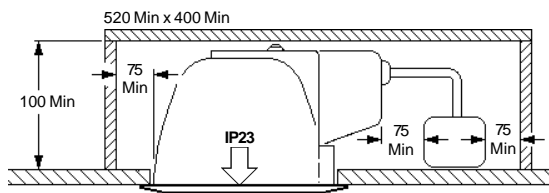
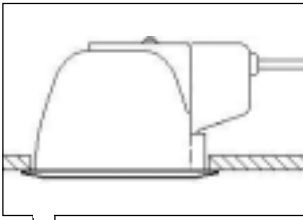

Installation Instructions
IS1150 Accessories

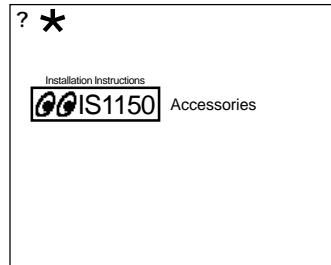
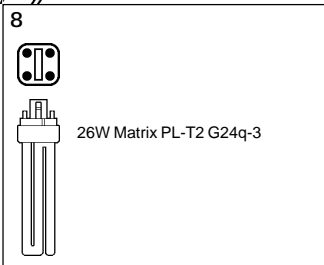
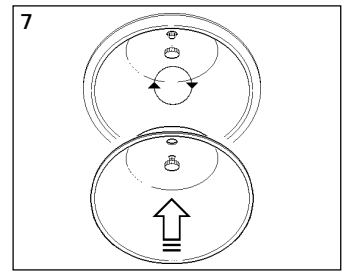
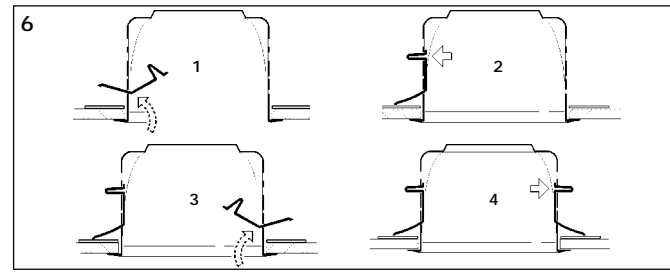
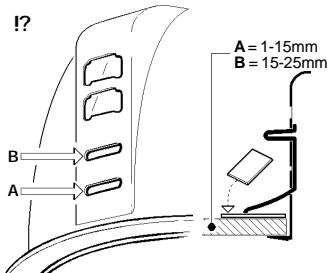
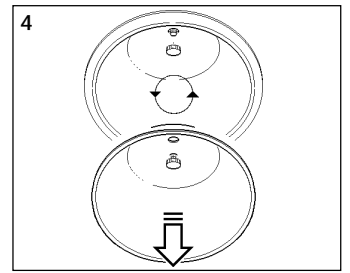
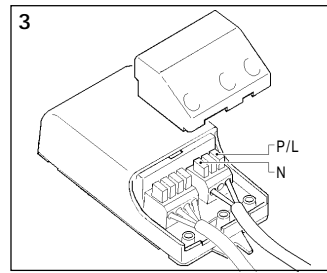
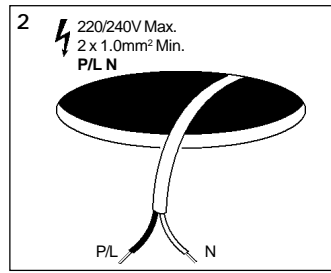
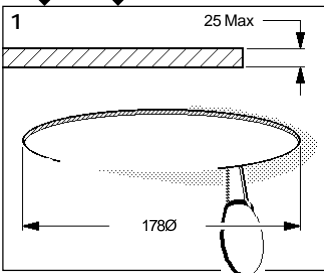
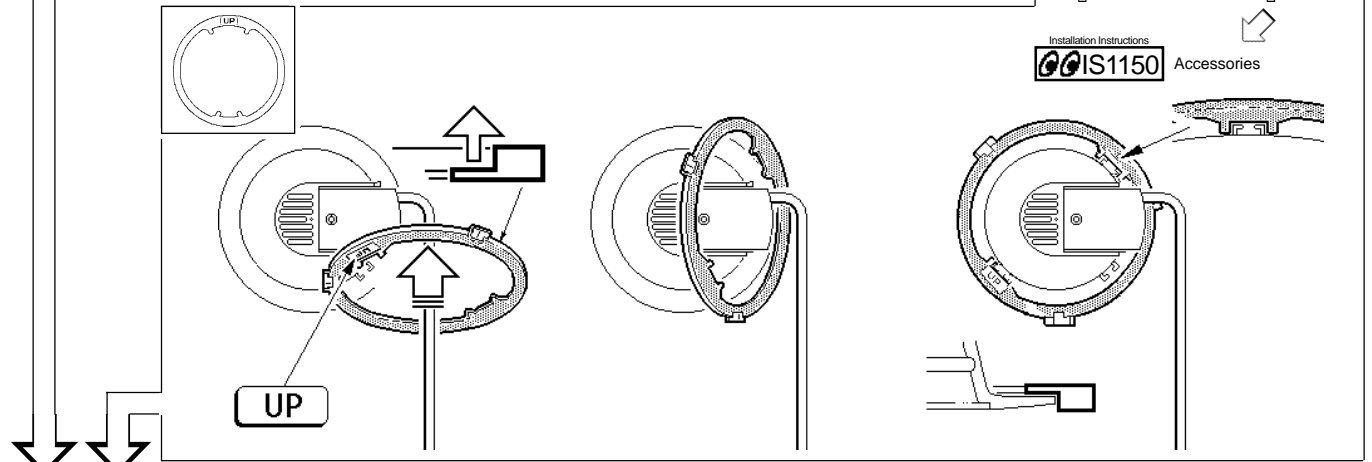

Suitable for use indoors
 Geeignet für Innenanwendung
 Pour un usage interne
 Adecuada para uso en interiores
 Geschikt voor gebruik binnen
 Lämpig för inomhusbruk



< Millimetres >



This Electrical Product MUST be recycled.



05.08

Concord

Avis Way Newhaven East Sussex BN9 0ED
 T 0870 606 2030 F 01273 512 688 email: information@concordmarlin.com

