

Isolate from the mains supply before any maintenance.

Vor Wartungsarbeiten von der Netzspannung trennen.

Veillez isoler le luminaire du courant avant toute maintenance.

Aislar de la red eléctrica antes de cualquier operación de mantenimiento.

Koppel het toestel af van de netspanning voor elk onderhoud.

Isolera från elnätet innan något underhåll.

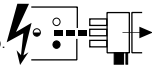

Switch Off
Abschalten
Débrancher
Desconectar
Uitschakelen
Stäng av

- 49516 49518 49519 49535
- 49539 49555 49559 49575
- 49580 49596 49599 49625
- 49626 49645 49646 49665
- 49666 49670 49671 49686
- 49715 49716 49717 49718
- 49735 49736 49737 49738
- 49755 49760 49775 49776
- 49779 49805 49807 49808
- 49809 49827 49828 49829
- 49846 49866 49869 49880
- 49882 49884 49885 49886
- 49887

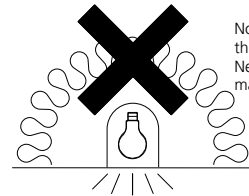

Not suitable for covering with thermally insulating material.
Ne doit pas être recouvert un matériau isolant thermique.

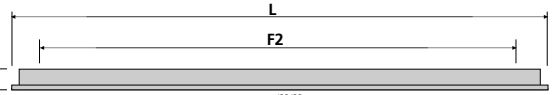
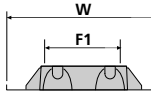
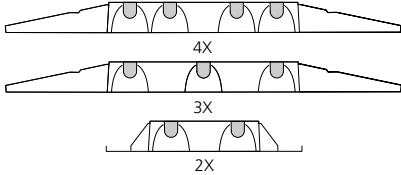
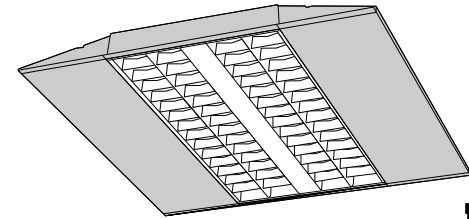

mm		mm		mm		mm		mm		mm		mm		mm		mm		
W	L	F1	F2	H	Kg.	W	L	F1	F2	H	Kg.	W	L	F1	F2	H	Kg.	
2 x 14W/2 x 24W	594/619	592/621	- 265	- 500	- 46	- 3.0*												
2 x 28W/2 x 54W	294/306	1196/1246	-145	- 1100	- 46	- 3.2*												
3 x 14W/3 x 24W	594/619	592/621	- 265	- 500	- 46	- 3.0*												
4 x 14W/4 x 24W	594/619	592/621	- 265	- 500	- 46	- 3.0*												

*Not including Emergency

230-240V
0.75mm² Min.

EB MPM

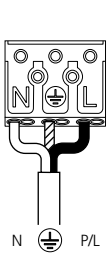

DB 1-10V MPM

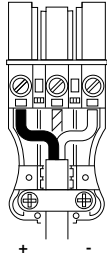

DB DA MPM

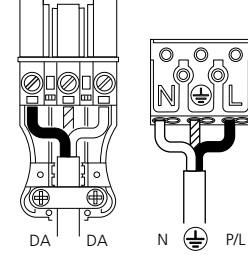

EB E3 MPM

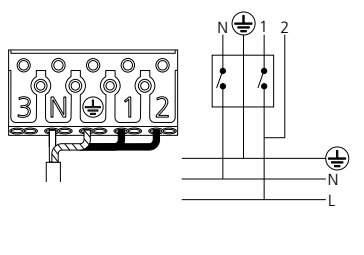

2*28W Only

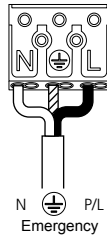
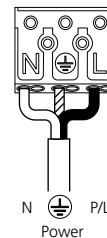

DAMA MPM

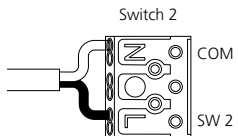
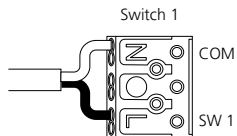
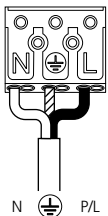

DALI 2 32mA Max.

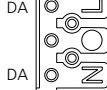

DALI 1 42mA Max.

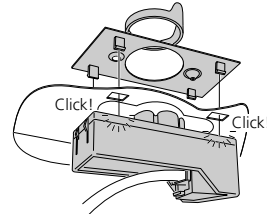
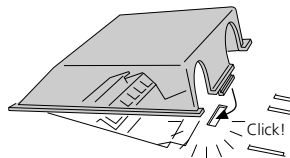
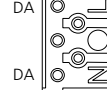

EB

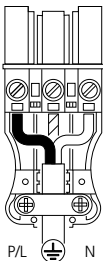

DB 10

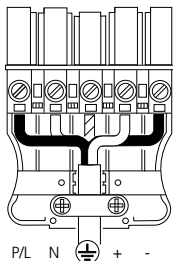

DB DA

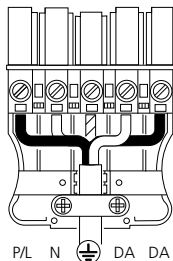

EB E3

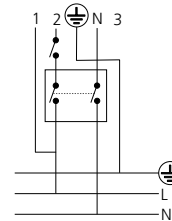
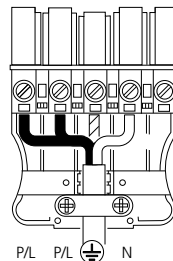

☒ ⚡ ?

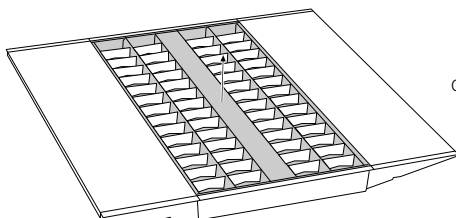

OR

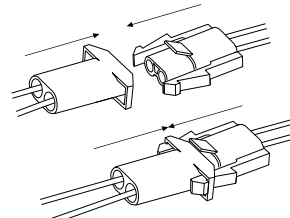
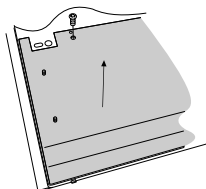

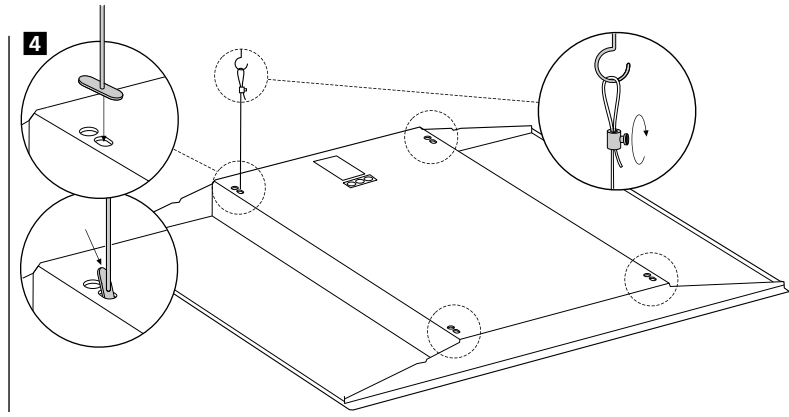
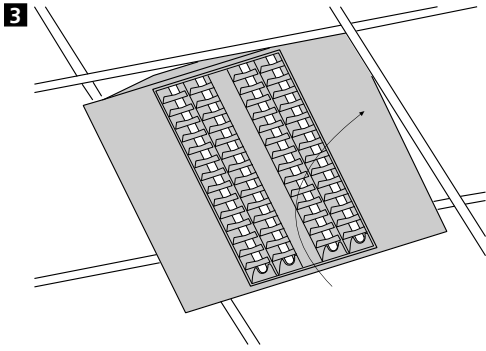

3 Pull Up

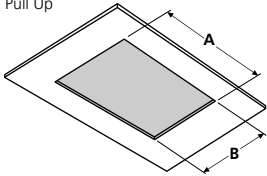

	A	B	L	I	E	e	F	f	H
3/4 x 14/24W	295	574	596	314	572	290	500	265	46
2 x 28/54W	174	1174	1196	193	1172	169	1100	145	46

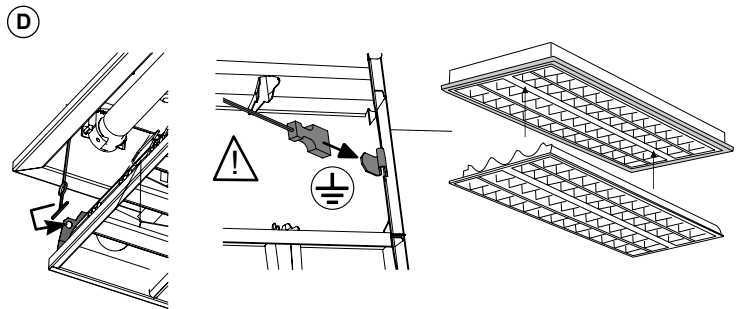
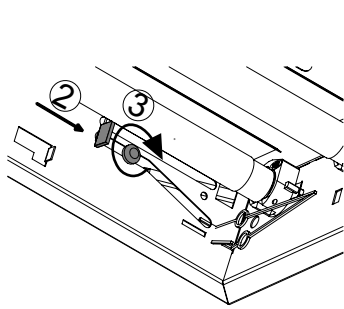
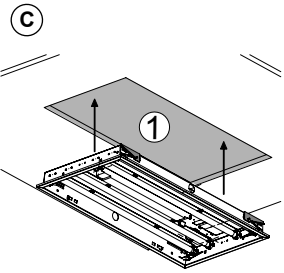
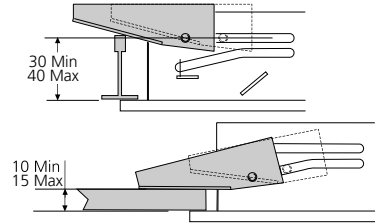
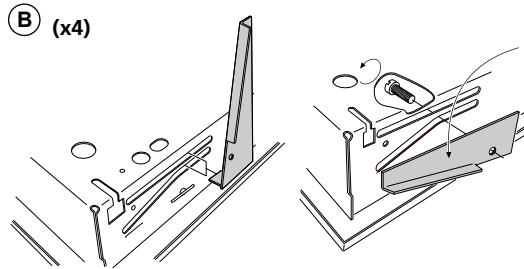
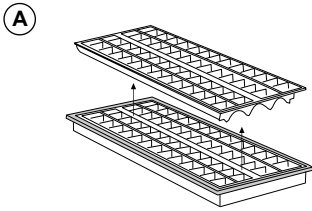
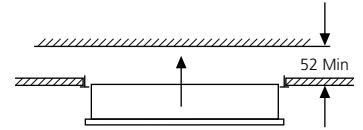

4

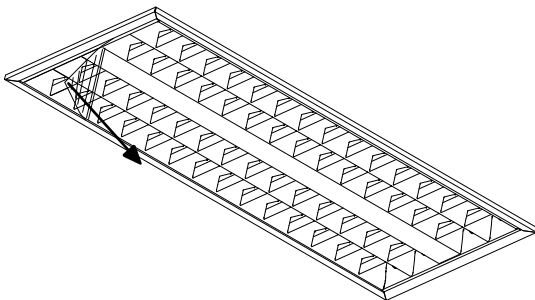

Suitable for use indoors

Geeignet für Innenanwendung

Pour un usage interne

Adecuada para uso en interiores

Geschikt voor gebruik binnen

Lämplig för inomhusbruk

Replace any cracked protective shield.

Dieses symbol bedeutet, dass defekte schutzgläser sofort ersetzt werden müssen.

Ce symbol indique que vous devez remplacer tout verre de protection fêlé.

Este simbolo indica que hay que reemplazar filtros en caso de rotura o desperfectos.

Dette symbolet indikerer at alle ødelagte (sprukne) sikkerhetsglass må skiftes.

Valaisinta el saa käyttää ilman suojalasia vioitunut suojalasi on vaihdettava uuteen ennen valaisimen käyttöön ottoa.