

3030174-5 DB  
 3032829-30 MW \*\*  
 3032867-8 DALI  
 3032881-2 DALI MW \*\*

Isolate from the mains supply before any maintenance.  
 Vor Wartungsarbeiten von der Netzspannung trennen.

**Veillez isoler le luminaire du courant avant toute maintenance.**  
 Aislar de la red eléctrica antes de cualquier operación de mantenimiento.  
**Koppel het toestel af van de netspanning voor elk onderhoud.**  
 Isolera från elnätet innan något underhåll.

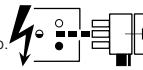

**Switch Off**  
 Abschalten  
**Débrancher**  
 Desconectar  
**Uitschakelen**  
 Stäng av

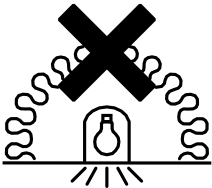

Not suitable for covering with thermally insulating material  
 Ne doit pas être recouvert un matériau isolant thermique

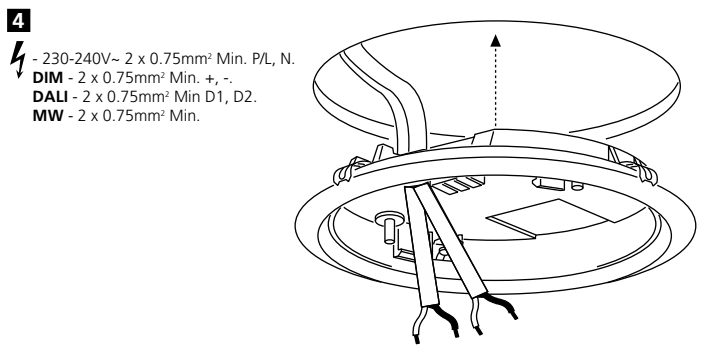
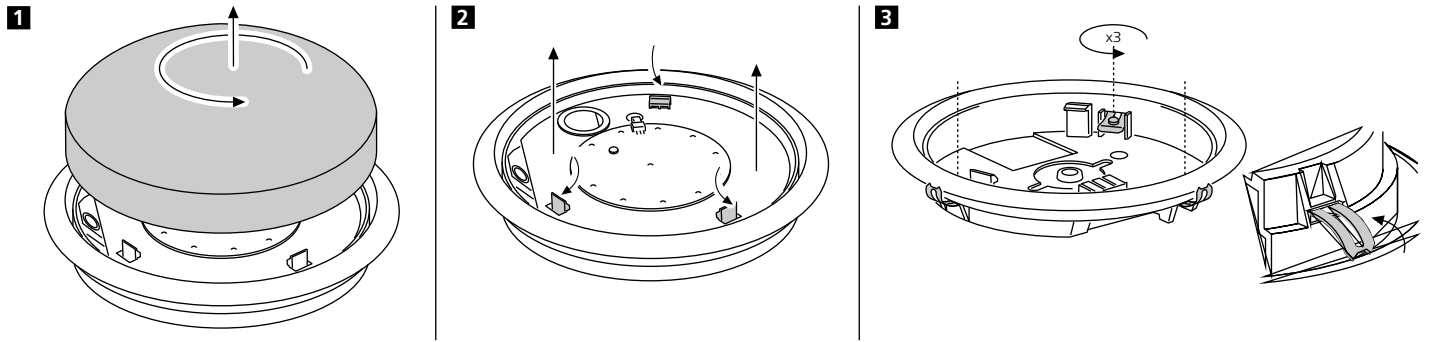
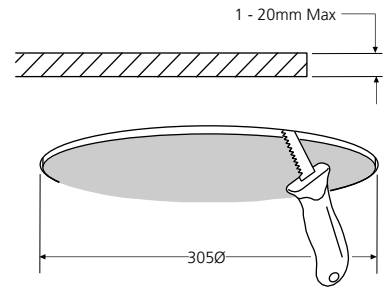
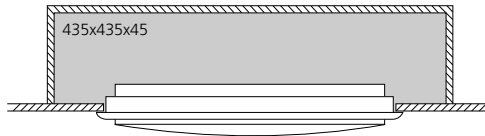

**⚡** - 230-240V~ 2 x 0.75mm<sup>2</sup> Min. P/L, N.  
**DIM** - 2 x 0.75mm<sup>2</sup> Min. +, -  
**DALI** - 2 x 0.75mm<sup>2</sup> Min D1, D2.  
**MW** - 2 x 0.75mm<sup>2</sup> Min.

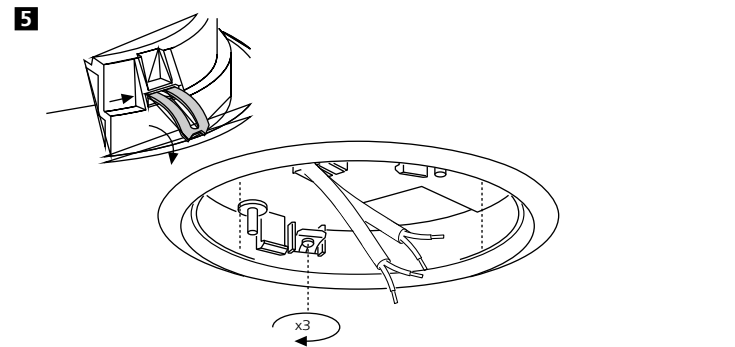

**⚡** - 230-240V~ 3 x 0.75mm<sup>2</sup> Min. 2 x P/L, N. **DIM** - 2 x 0.75mm<sup>2</sup> Min. +, -. **DALI** - 2 x 0.75mm<sup>2</sup> Min D1, D2. **MW** - 2 x 0.75mm<sup>2</sup> Min.

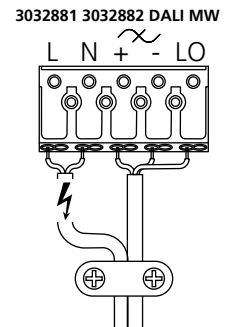
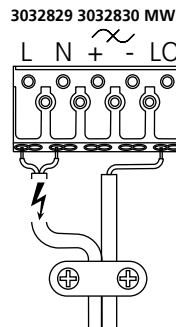
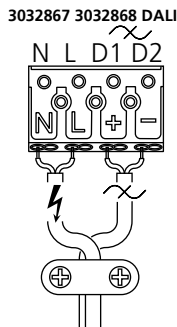
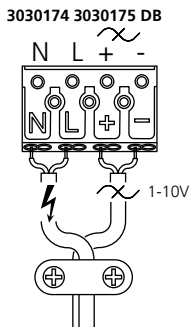

**7** ENSURE DRIVER HAS **NOT** BEEN POWERED FOR AT LEAST 1(ONE) MINUTE **BEFORE** CONNECTING LED STRING.

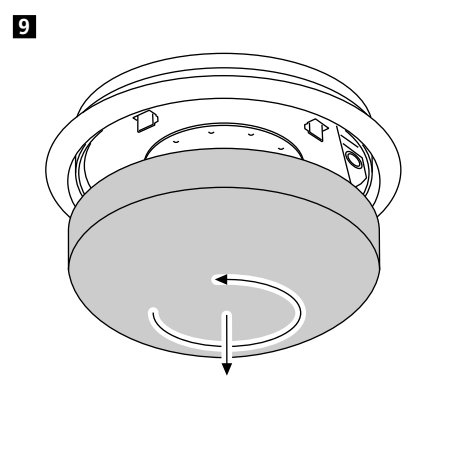
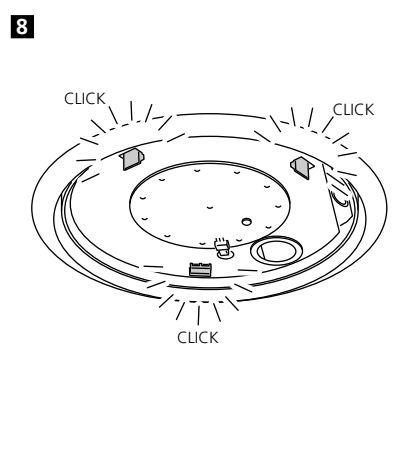
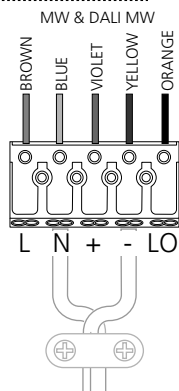
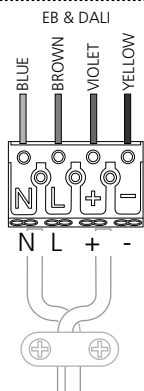

\*\*

**Microwave Set-up.**

Positioning.  
 The detector should be sited so that the occupants of the room fall inside the detection pattern shown in Fig. A. Please note that when ceiling mounting, the recommended ceiling height of the sensor head is 2.4m. Note that the lower the sensor is installed the smaller the detection range will be, subject to the parameters shown on the diagram.  
 Avoid direct sunlight entering the sensor.  
 Do not site within 1m of forced air heating or ventilation.  
 Do not fix to a vibrating surface.  
 Avoid metallic objects directly in front of the sensor head.  
 Do not fit to a suspended luminaire.

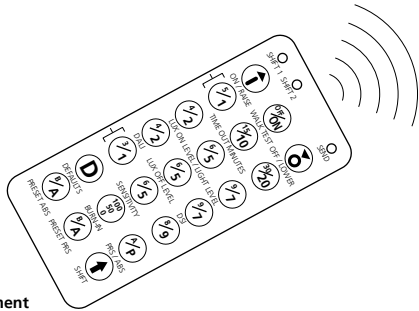

**Infra red Handset Adjustment**

1. The functionality of the microwave unit is controlled by a number of parameters which can be changed or programmed by an infra red handset.
2. Point the handset at the sensor and send the required programming commands to the unit.
3. For full programming details see the user guide supplied with the handset.

Fig. A

Please note that when the sensor head is behind a glass/polycarbonate diffuser it will reduce the detection range by approximately 20%.

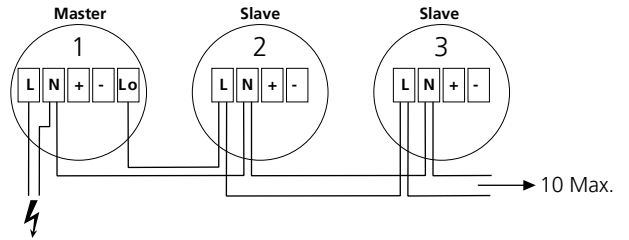
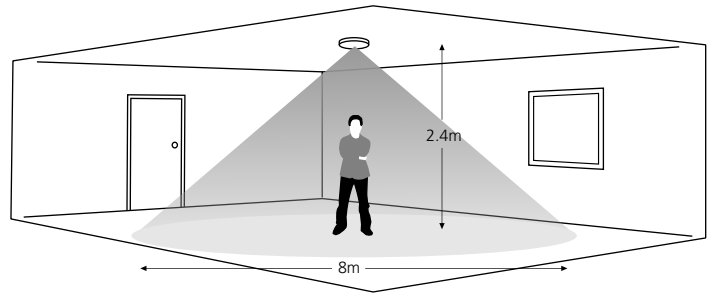

**Fault Finding**

**Load does not come on?**

Check to see if the live supply to the circuit is good. Strap across the L and LIVE OUT (where used) terminal to turn the load on.  
 If the supply and wiring are good, check the LUX level setting. Increase the LUX level setting to allow the controller to turn on at higher ambient natural light level.

**Lights do not go off?**

Ensure that the area is left unoccupied for longer than the selected timer setting.  
 Make sure that the sensor is not adjacent to circulating air, heaters or lamps.  
 If the unit 'false triggers' reduce the sensitivity using the sensitivity settings.

**Suitable for use indoors**

Geeignet für Innenanwendung  
**Pour un usage interne**  
 Adecuada para uso en interiores  
**Geschikt voor gebruik binnen**  
 Lämplig för inomhusbruk

**Replace any cracked protective shield.**  
 Dieses symbol bedeutet, dass defekte Schutzgläser sofort ersetzt werden müssen.  
**Ce symbol indique que vous devez remplacer tout verre de protection fêlé.**  
 Este simbolo indica que hay que 'reemplazar filtros en caso de rotura o desperfectos'.  
**Dette symbolet indikerer at alle ødelagte (sprukne) sikkerhetglass må skiftes.**  
 Valaisinta el saa käyttää ilman suojalasia vioittunut suojalasi on vaihdettava uuteen ennen valaisimen käyttöön ottoa.

