

- 3044600-3044615
- 3044616-3044631 ✂
- 3044640-3044647
- 3044648-3044655 ✂
- 3044660-3044675
- 3044676-3044691 ✂
- 3044700-3044707
- 3044708-3044715 ✂

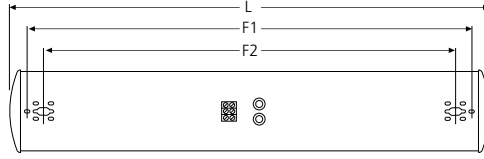

Isolate from the mains supply before any maintenance.
 Vor Wartungsarbeiten von der Netzspannung trennen.
Veillez isoler le luminaire du courant avant toute maintenance.
 Aislar de la red eléctrica antes de cualquier operación de mantenimiento.
Koppel het toestel af van de netspanning voor elk onderhoud.
 Isolera från elnätet innan något underhåll.

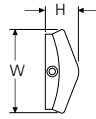
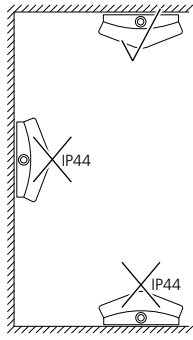
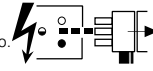

Switch Off
 Abschalten
Débrancher
 Desconectar
Uitschakelen
 Stäng av

Dimensions (mm)

	L	W	H	F1	F2
1 x 28/54W	1218	200	85	1050	1130
1 x 35/49W	1518	200	85	1350	1430
2 x 14W	618	200	85	450	530
2 x 28/54W	618	200	85	1050	1130
2 x 32/35/45/49W	1518	200	85	1350	1430

The installation instructions are organized into a 4x3 grid of steps:

- Row 1:** Overview diagrams for each mounting type: surface mount (F2), recessed mount (F1), and suspended mount (F2).
- Row 2 (Step 1):** Drilling holes in the ceiling. For surface and recessed mounts, holes are 5mm diameter. For the suspended mount, a hole is drilled for the suspension arm (3044720).
- Row 3 (Step 2):** Preparing the ceiling surface. For surface and recessed mounts, a hole is cut into the ceiling. For the suspended mount, the suspension arm is attached to the ceiling.
- Row 4 (Step 3):** Mounting the light fixture to the ceiling.
- Row 5 (Step 4):** Final assembly and bulb insertion. The light fixture is secured to the ceiling, and the bulb is inserted and tightened.

⚡ 1.0mm² Min.

Standard

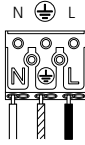

DALI

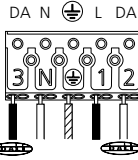

Emergency

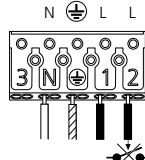

DALI + Emergency

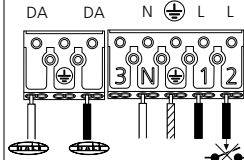

DALI + Sensor

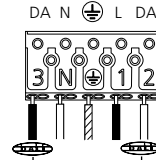

DALI + Emergency + Sensor

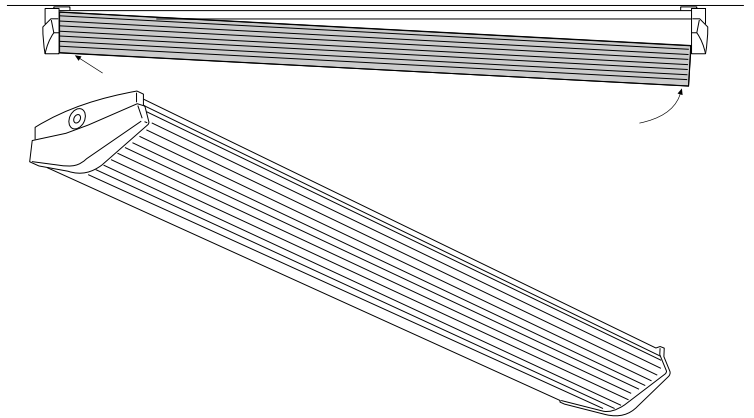
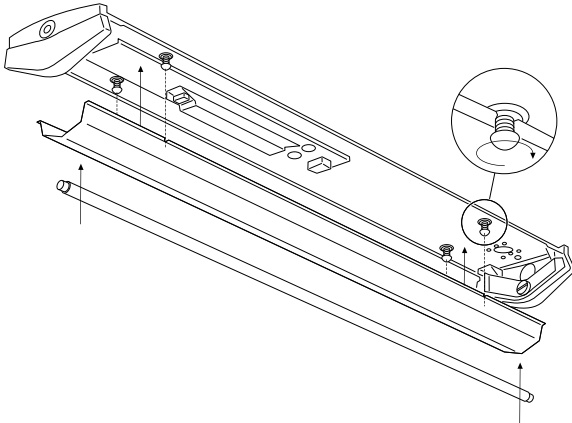
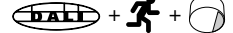
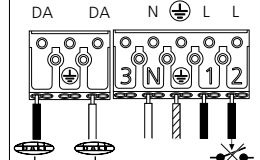

Routine Testing

Testing should be carried out in accordance with the recommendations of BS5266.

1. A monthly functional test.
2. Twice yearly, a one hour test.
3. Every three years, a full three hour duration test.

The above tests assume a three hour system.

4. Batteries should be replaced when the luminaire no longer meets the 3 hours duration performance.
5. Testing could be performed by interrupting the fixed phase supply for the test duration, during which the luminaire should remain lit.
6. Ensure that the 'LED' is 'OFF' during 'Discharge Mode', and 'ON' during 'Charging Mode'.

To assist with this testing, a test card is included below.

If the charge indicator (LED) is unlit, this signifies a fault. To increase the chance of a fault being reported between monthly tests, it is desirable that staff are made aware of the purpose of the indicator.

This module should not be modified or repaired by any person other than those nominated by the manufacturer. ANY unauthorised modifications may render the module unsafe and will invalidate our warranty and conformance to any safety standards that may apply. The company will accept no responsibility for any modified modules, or for damage caused as a result of modifications.

All details are given for guidance only and do not constitute a contract. We reserve the right to change the characteristics of products without notice.

Test Record

Type:.....	Location:.....	1st Year	2nd Year	3rd Year	4th Year	5th Year
Month	Test					
	1. Functional					
	2. Functional					
	3. Functional					
	4. Functional					
	5. Functional					
	6. Functional					
	7. Functional					
	8. Functional					
	9. One Hour					
	Three Hour					
	10. Functional					
	11. Function					
	12. Functional					

Suitable for use indoors

- Geeignet für Innenanwendung
- Pour un usage interne**
- Adecuada para uso en interiores
- Geschikt voor gebruik binnen**
- Lämplig för inomhusbruk

- Replace any cracked protective shield.**
- Dieses symbol bedeutet, dass defekte schutzgläser sofort ersetzt werden müssen.
- Ce symbol indique que vous devez remplacer tout verre de protection fêlé.**
- Este simbolo indica que hay que 'reemplazar filtros en caso de rotura o desperfectos'.
- Dette symbolet indikerer at alle ødelagte (sprukne) sikkerhetsglass må skiftes.**
- Valaisinta el saa käyttää ilman suojalasia vioittunut suojalasi on vaihdettava uuteen ennen valaisimen käyttöön ottoa.

