

A & B 2054914

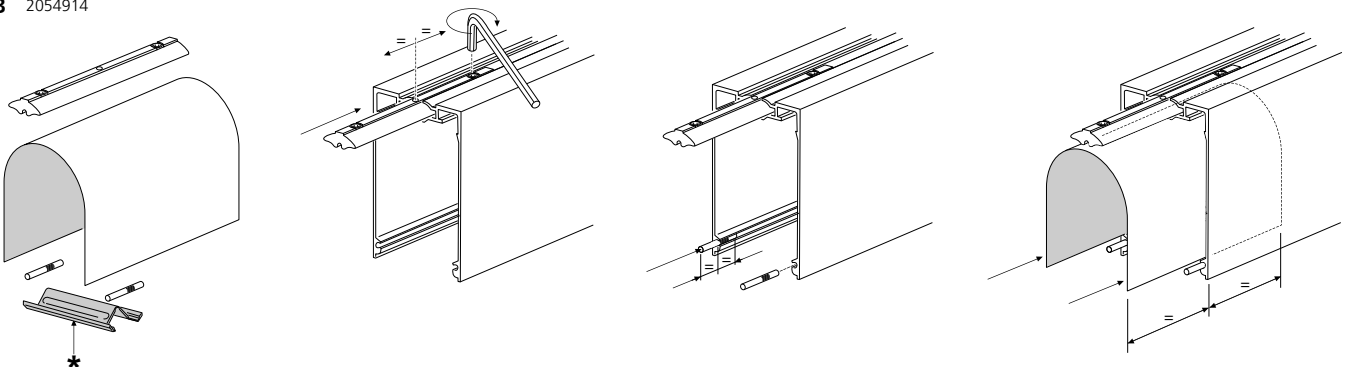

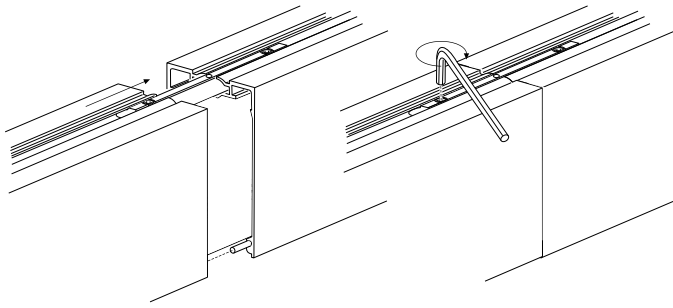

* A & B

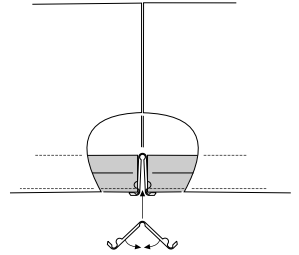
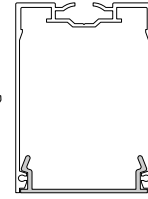
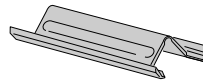

A & B

230-240V

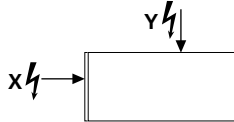

X

2054912
2054913

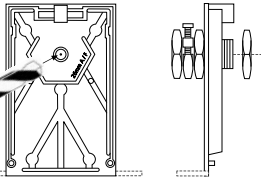

Y

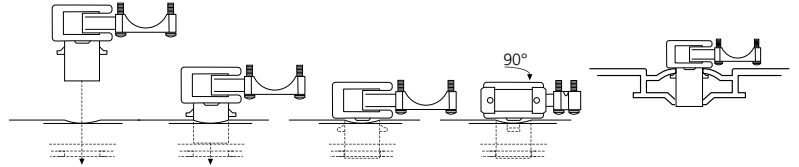
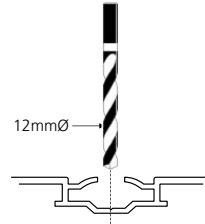

2054915
2055380

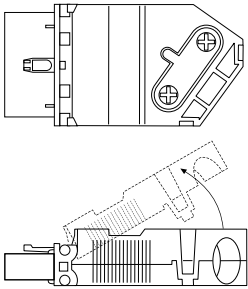

2054872-2054880
2054890-2054898
2056002-2056007
2056014-2056019

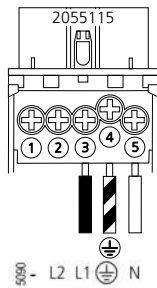

3 x 0.75mm² Min.

2054881-2054889
2054899-2054907

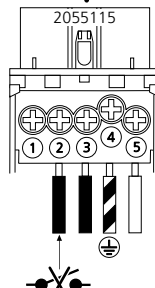

4 x 0.75mm² Min.

2055079-2055087
2055097-2055105
2056008-2056013
2056020-2056025

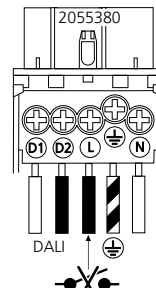

5 x 1.5mm² Min.

2055088-2055096
2055106-2055114

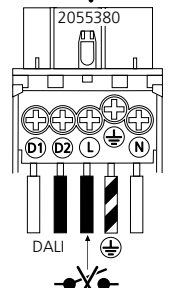

5 x 1.5mm² Min.

