

Disconnect from mains supply before replacing the fuse or the lamp.
Vor dem Einsetzen der Sicherung oder der Lampe Spannungsfreiheit herstellen.
Débrancher le secteur avant de remplacer le fusible ou l'ampoule.
Desconectar del suministro de la red, antes de realizar la sustitución del fusible o de la lámpara.
Voor het vervangen van lamp of zekering, eerst netspanning uitschakelen.
Koppla bort spänningen före byte av en säkring eller en lampa.

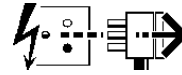

Switch Off
Abschalten
Débrancher
Desconectar
Uitschakelen
Stäng av

Installation should be carried out by a suitably qualified person in accordance with good electrical practice and the appropriate national wiring regulations.

Switch off mains electrical supply before commencing installation.

Installation Procedure

Screw in appropriate lamp as shown on labels (A).

Louvre Accessory (F)

Unscrew trim screws (D) and remove trim (E), shield (C) and seal (G).

Discard shield (C). Locate louvre (F) and seal (G) in trim (E) and secure assembly in position.

C Type (Fig. 1.)

Pass mains supply cable through plate (A) and secure plate in position using suitable screws.

Connect luminaire leads in terminal block supplied.

Connect supply leads in terminal block (see diagram below). Push terminal block on lugs (B). Secure luminaire to plate (A).

D Type (Fig. 2 & 3)

Set adaptor dials as shown in Fig. 2 and fully insert adaptor in track.

NOTE: Adaptor will only enter track one way. Turn dial clockwise to lock adaptor in track.

Turn circuit selector dial to appropriate setting as shown in Fig. 3.

To remove luminaire from track set dials as shown in Fig. 2.

J Type (Fig. 4)

Insert adaptor in track, press firmly and turn clockwise to fully engage catch (A).

NOTE: Adaptor will only enter track one way.

To remove luminaire from track, pull down catch (A) and turn adaptor anti-clockwise.

Protection of electrical circuit is provided by a F3A fuse (B).

WARNING: This luminaire must be earthed.

NOTE: This luminaire should be cleaned using warm soapy water and a soft cloth. Ensure luminaire is switched off during cleaning.

Dispose of lamps in accordance with manufacturer's instructions.

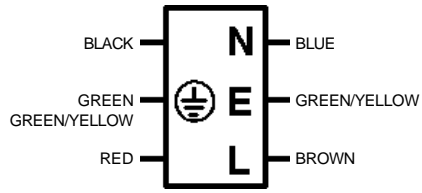
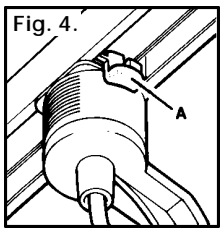
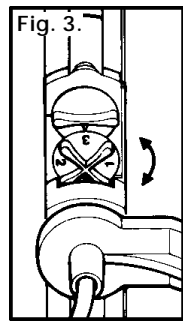
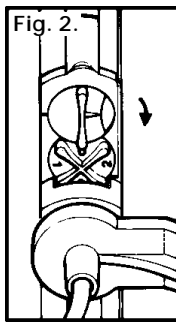
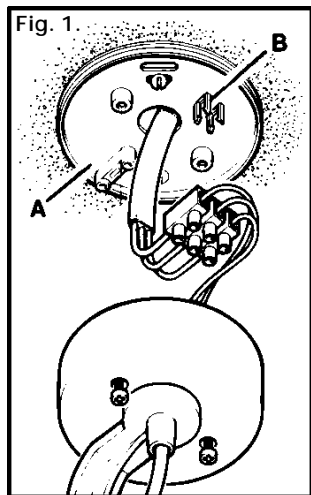
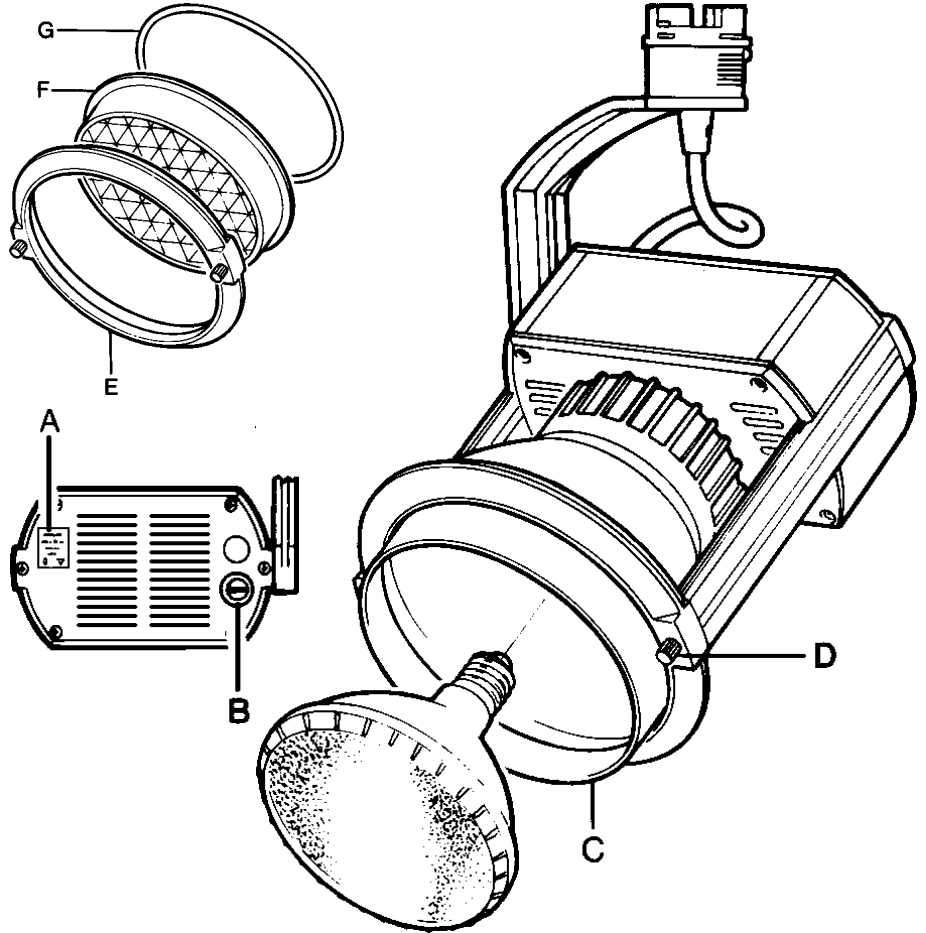

Suitable for use indoors
 Geeignet für Innenanwendung
Pour un usage interne
 Adecuada para uso en interiores
Geschild voor gebruik binnen
 Lämplig för inomhusbruk

Replace any cracked protective shield.
 Dieses Symbol bedeutet, dass defekte Schutzgläser sofort ersetzt werden müssen.
Ce symbole indique que vous devez remplacer tout verre de protection fêlé.
 Este símbolo indica que hay que reemplazar filtros en caso de rotura o desperfectos.
Dette symbolet indikerer at alle ødelagte (sprukne) sikkerhetsglass må skiftes.
 Valaisinta ei saa käyttää ilman suoja-alasia vioitunut suoja-lasi on vaihdettava uuteen ennen valaisimen käyttöön ottoa.

< Millimetres > This Electrical Product **MUST** be recycled.

