

- 4044692 4044693 4044698 4044699 4044704
- 4044705 4044716 4044717 4044722 4044723
- 4044728 4044729 4044734 4044735 4044746
- 4044747 4044752 4044753 4044758 4044759
- 4044764 4044765 4044776 4044777 4044782
- 4044785 4044788 4044794 4044797 4044800
- 4044803 4044809 4044812 4044813 4044816
- 4044817 4044820 4044821 4044829 4044830
- 4044833 4044834 4044837 4044838 4044841
- 4044842 4044850 4044851 4044854 4044855
- 4044860 4044861 4044867 4044868 4044869
- 4044880 4044881 4044886 4044889 4044892
- 4044898 4047656 4057701 4057702 4057705
- 4057706 4057713 4057714 4057718 4057719
- 4057727 4057728 4057732 4057739 4057741
- 4057745 4057746 4057748 4057752 4057753
- 4057756 4057757 4057764 4057765 4057768
- 4057776 4057777 4057780 4057781 4057788
- 4057791 4146961 4146962 4147590 4147595
- 4147596 4147605 4147606 4147607 4147609
- 4147613 4147614 4147616 4147627 4147628
- 4147630 4147633 4147634 4147636 4147643
- 4147646 4147648 4147649 4147654 4147658
- 4147659 4147671 4147673 4147675 4147676
- 4147680 4147683 4147684 4147686 4147692
- 4147696 4147697 4147698 4147700 4147701
- 4147703 4147705 4147706 4147709 4147710
- 4147712 4147714 4147719 4147720 4147722
- 4147723 4147724 4147726 4147738 4147741
- 4147754 4147747 4147750 4147751 4147752
- 4147760 4156812 4156814 4156815 4156818
- 4156822 4156824 4156826 4157895 4158036
- 4158046 4158047 4158049 4158053 4158054
- 4158058 4158059 4158062 4158064 4158066
- 4158069 4158075 4158077 4158078 4158080
- 4160139 4160140 4160736 4160737 4160812
- 4161030 4161055 4161056 4161058 4161229
- 4161231 4161234 4161235 4161595 4161859
- 4161861 4162153 4162155 4162207 4162654
- 4163002 4163085 4163524 4163547 4163554
- 4163583 4163585 4163588 4164136 4164272
- 4164305 4164325 4164345 4164378 4164381
- 4164385 4164451 4164453 4164477 4164563
- 4164564 4164565 4164591 4164599 4164603
- 4164605 4164686 4164699 4164858 4164882
- 4164884 4164908 4165101 4165511 4165537

Disconnect from mains supply before replacing the fuse or the lamp.
Vor dem Einsetzen der Sicherung oder der Lampe Spannungsfreiheit herstellen.
Débrancher le secteur avant de remplacer le fusible ou l'ampoule.
Desconectar el suministro de la red, antes de realizar la sustitución del fusible o de la lámpara.
Voor het vervangen van lamp of zekering, eerst netspanning uitschakelen.
Koppla bort spänningen före byte av en säkring eller en lampa.

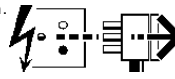

Switch Off
Abschalten
Débrancher
Desconectar
Uitschakelen
Stäng av

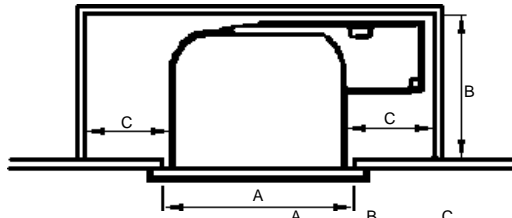

	A	B	C
1 x 13/18W	175	140	75
1 x 26/32W 2 x 13/18W	200	148	75
1 x 42W 2 x 26/32W	225	159	75
2 x 42W	250	171	75

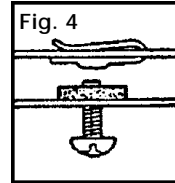
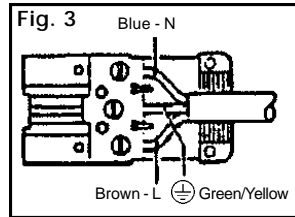
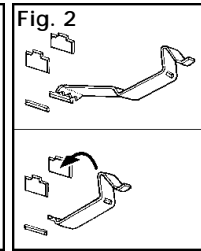
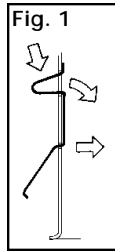

Trim Type	Ceiling Thickness (mm)	Fixing Slot
Flat	5 - 16	Bottom
	16 - 31	Top
Profile	1 - 10	Bottom
	10 - 25	Top

To avoid flexing of sheet metal tiles use a 6mm backing board.

This downlight is suitable for interior ceiling mounting.

The lamp housing and gear unit are modular components designed for plug and snap assembly. The trim is a loose fit to facilitate interchangeability with alternative components.

Installation should be carried out by a suitable qualified person in accordance with good electrical practice and the appropriate national wiring regulations.

Switch off mains electrical supply before commencing installation.

Installation Procedure

Refer to table for aperture and recess dimensions.

Prepare aperture in mounting surface.

If applicable, remove retaining knobs and glass (see Fig. 5).

Remove reflector (A) and check voltage rating on label (D) conforms with mains electrical supply.

Remove mounting clips (B) from reflector housing (C) as shown in Fig. 1.

Remove plug (F) from gear unit (E) and connect switched mains supply to plug as shown in Fig. 3.

Insert plug (F) in gear unit socket.

Refer to table and secure housing (C) in ceiling aperture with mounting clips (B) as shown in Fig. 2.

Fit reflector (A) in housing (C), ensuring that rubber washer is positioned on end of screw as shown in Fig. 4.

Fit supplied lamp/s.
 If applicable, replace glass and secure with retaining knobs (see Fig. 5).

NOTE: The luminaire is protected by a 3A fuse (G).

WARNING Luminaire must be earthed.

WARNING: Do not insulation test.

WARNING Any external cable or wiring must not come into contact with gear unit unless heat resistant up to 85°C.

NOTE: For optimum performance Concord recommend the use of PHILIPS PL-T lamps (with the exception of 13W lamp version when a GE Biax-TE is recommended).

Dispose of lamps in accordance with manufacturer's instructions.

NOTE: This luminaire should be cleaned with warm soapy water and a soft cloth - ensure luminaire is switched off during cleaning.

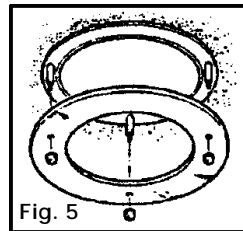
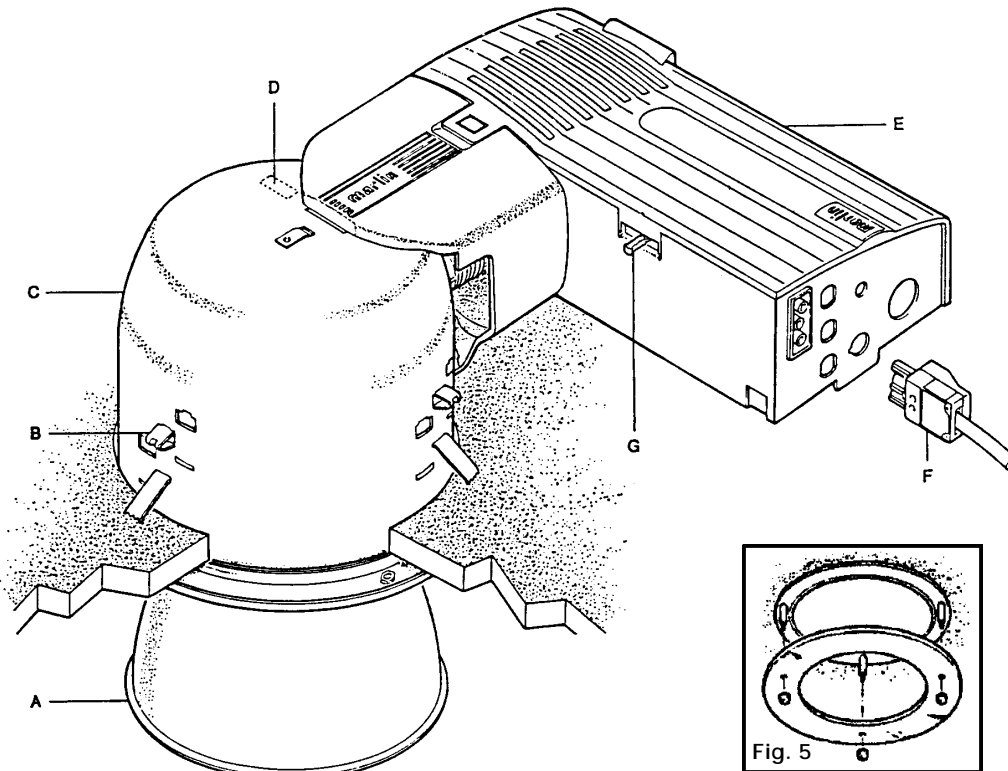

Suitable for use indoors
 Geeignet für Innenanwendung
 Pour un usage interne
 Adecuada para uso en interiores
 Geschikt voor gebruik binnen
 Lämpelig för inomhusbruk



Replace any cracked protective shield.
 Dieses symbol bedeutet, dass defekte Schutzgläser sofort ersetzt werden müssen.
Ce symbol indique que vous devez remplacer tout verre de protection fêlé.
 Este símbolo indica que hay que reemplazar filtros en caso de rotura o desperfectos.
Dette symbolet indikerer at alle ødelagte (sprukne) sikkerhetglass må skiftes.
 Valaisinta ei saa käyttää ilman suojalasia vioitunut suojalasi on vaihdettava uuteen ennen valaisimen käyttöön ottoa.

< Millimetres >

