

4044904  
4057795

Use supplied polythene glove when handling reflector and lamp.

**Disconnect from mains supply before replacing the fuse or the lamp.**  
**Vor dem Einsetzen der Sicherung oder der Lampe Spannungsfreiheit herstellen.**  
**Débrancher le secteur avant de remplacer le fusible ou l'ampoule.**  
**Desconectar del suministro de la red, antes de realizar la sustitución del fusible o de la lámpara.**  
**Voor het vervangen van lamp of zekering, eerst netspanning uitschakelen.**  
**Koppla bort spänningen före byte av en säkring eller en lampa.**

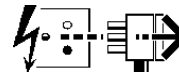

**Switch Off**  
**Abschalten**  
**Débrancher**  
**Desconectar**  
**Uitschakelen**  
**Stäng av**

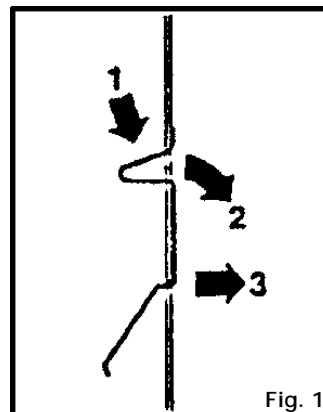
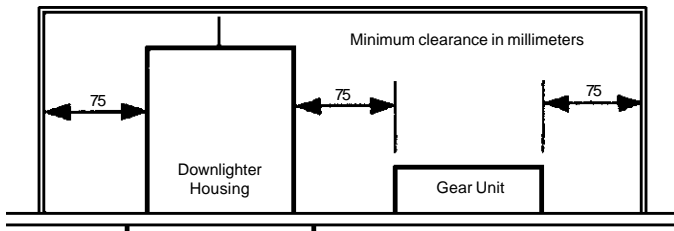

This downlighter is suitable for interior ceiling mounting.

This downlighter requires a 250mm diameter aperture and a recess depth of 215mm.  
 NOTE: For recessed enclosure refer to diagram.

Installation should be carried out by a suitably qualified person in accordance with good electrical practice and the appropriate national wiring regulations.

Switch off mains electrical supply before commencing installation.

**Installation Procedures**

Prepare aperture in mounting surface.

Remove retaining knobs (A) and protective glass cover (B).

Remove reflector (C) and check rating marked on label conforms with mains electrical supply.

Remove mounting clips (D) from reflector housing (E) as shown in Fig. 1.

Remove plug (H) from gear unit (G) and connect switched mains supply to plug as shown in Fig. 3.

Insert plug (H) in gear unit socket.

Place remote box (G) through ceiling aperture.

Refer to table on left and secure housing (E) in ceiling aperture with mounting clips (D) as shown in Fig. 2.

Fit reflector (C) in housing (E), ensuring that rubber washer is positioned on end of screw as shown in Fig. 4.

Fit supplied lamps.

Replace protective glass cover (B) and secure with retaining knobs (A).

NOTE: Luminaire is protected by a 3A fuse (F).

IP44 Rating - With protective glass cover fitted, any mounting surface must be closed to prevent ingress of water into ceiling void from below.

WARNING: Luminaire must be earthed.

WARNING: Do not insulation test.

NOTE: For optimum performance Concord recommend the use of Philips PL-T lamps.

NOTE: This luminaire should be cleaned using warm soapy water and a soft cloth - ensure luminaire is switched off during cleaning.

Dispose of lamps in accordance with manufacturer's instructions.

**Clips**

Trim Type	Ceiling Thickness (mm)	Fixing Slot
Flat	5 - 16 16 - 31	Bottom Top
Profile	1 - 10 10 - 25	Bottom Top

To avoid flexing of sheet metal tiles use a 6mm backing board.

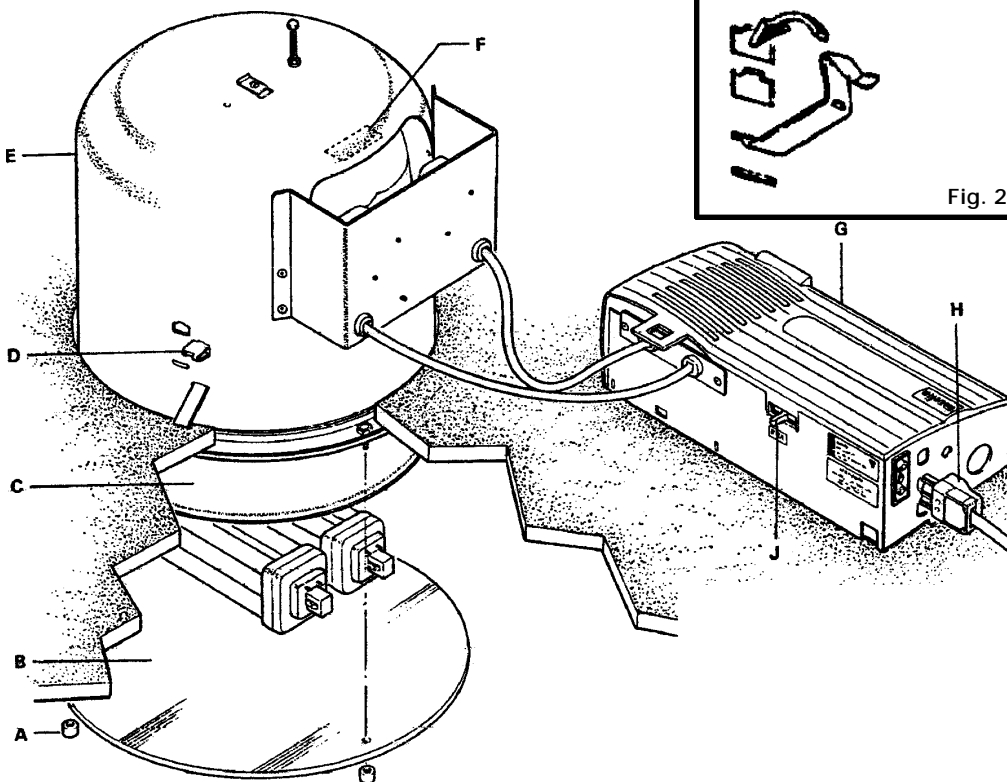
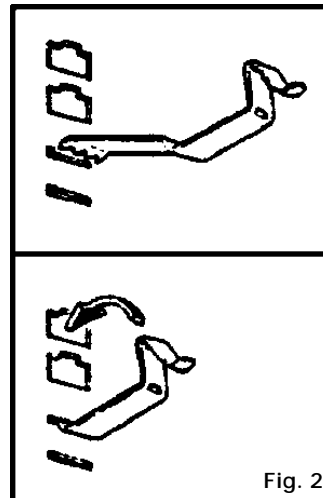
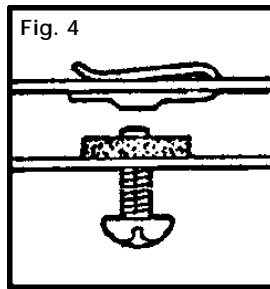
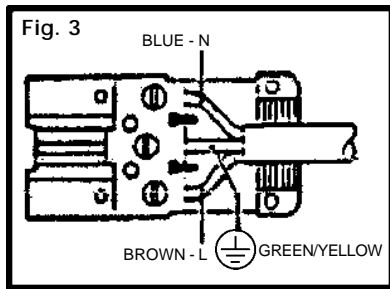

Suitable for use indoors  
 Geeignet für Innenanwendung  
 Pour un usage interne  
 Adecuada para uso en interiores  
 Geschikt voor gebruik binnen  
 Lämplig för inomhusbruk



Replace any cracked protective shield.

Dieses symbol bedeutet, dass defekte Schutzgläser sofort ersetzt werden müssen.

Ce symbole indique que vous devez remplacer tout verre de protection fêlé.

Este simbolo indica que hay que reemplazar filtros en caso de rotura o desperfectos.

Dette symbolet indikerer at alle ødelagte (sprukne) sikkerhetsglass må skiftes.

Valaisinta ei saa käyttää ilman suojalasiasa vioittunut suojalasi on vaihdettava uuteen ennen valaisimen käyttöön ottoa.

< Millimetres >



This Electrical Product **MUST** be recycled.



01.08