

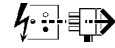

NB - To convert Torus 100 to Torus 100FX use Accessory Holder 2027235, 2027277 or 2027278. See over.

Disconnect from mains supply before replacing the fuse or the lamp.
 Vor dem Einsetzen der Sicherung oder der Lampe Spannungsfreiheit herstellen.
Débrancher le secteur avant de remplacer le fusible ou l'ampoule.
 Desconectar del suministro de la red, antes de realizar la sustitución del fusible o de la lámpara.
Voor het vervangen van lamp of zekering, eerst netspanning uitschakelen.
 Koppla bort spänningen före byte av en säkring eller en lampå.



Switch Off
 Abschalten
Couper le conector
 Desconectar
Uitschakelen
 Stäng av

Torus 20FX/35FX/70FX CDM-TC G8.5

Safety Lens

Flood Lens 2027234
 20FX - 37°
 35FX - 37°
 70FX - 39°

or

Elongation Lens 2027239
 20FX - 5:1
 35FX - 5:1
 70FX - 5:1

or

Spot Lens 2029686
 20FX - 6°
 35FX - 10°
 70FX - 11°

or

Wide Flood Lens 2032480
 20FX - 60°
 35FX - 60°
 70FX - 64°

or

Medium Spot Lens 2033450
 20FX - 20°
 35FX - 20°
 70FX - 24°

Torus 35FX/70FX CDM-T G12

Safety Lens

Flood Lens 2027234
 35FX - 28°
 70FX - 29°

or

Elongation Lens 2027239
 35FX - 5:1
 70FX - 5:1

or

Spot Lens 2027238
 35FX - 11°
 70FX - 12°

Torus 100FX

Safety Lens and Reflector

Standard Reflector

or

Optional Narrow Reflector 2020177

or

Optional Wide Reflector 2020178

Flood 2027234 + Reflector Standard - 34° or Wide - 60°

or

Spot Lens 2027238 + Reflector Standard - 8-12° or Narrow - 6°

or

Elongation 2027239 + Reflector Standard - 5:1 or Narrow - 4:1 or Wide - 6:1

or

Low Glare 2031577 + Reflector Standard - 8-14° or Narrow - 6° or Wide - 24°

or

Wide Flood 2032480 + Reflector Standard - 58°

or

Medium Spot Lens 2033450 + Reflector Standard - 24°

Torus 20FX/35FX/70FX/100FX

	Honeycomb	UV Filter	Daylight	Dydium Pink	Red	Amber	Mid Blue	Glare Shield	Barn Door	Gel Holder
2027240 Honeycomb	●	●	●	●	●	●	●	●	●	●
2027241 UV Filter	●	●	●	●	●	●	●	●	●	●
2027246 Daylight	●	●	●	●	●	●	●	●	●	●
2032127 Dydium Pink	●	●	●	●	●	●	●	●	●	●
2027244 Red	●	●	●	●	●	●	●	●	●	●
2027245 Amber	●	●	●	●	●	●	●	●	●	●
2032128 Mid Blue	●	●	●	●	●	●	●	●	●	●
2032460 Glare Shield	●	●	●	●	●	●	●	●	●	●
2032461	●	●	●	●	●	●	●	●	●	●
2032462	●	●	●	●	●	●	●	●	●	●
2032463 Barn Door	●	●	●	●	●	●	●	●	●	●
2032464	●	●	●	●	●	●	●	●	●	●
2032465	●	●	●	●	●	●	●	●	●	●
2032466 Gel Holder	●	●	●	●	●	●	●	●	●	●
2032467	●	●	●	●	●	●	●	●	●	●
2032468	●	●	●	●	●	●	●	●	●	●

Glass Filters

Honeycomb 2027240

UV 2027241

Daylight 2027246

Dydium 2032127

Red/Amber/Blue 2027244/2027245/2032128

Reflector (Torus 100FX Only)

Safety Lens

Filters (2027241 2027246 2032127)

Filters (2027240 2027241 2027246 2027244 2027245 2032128)

2031577 + 2027244 2027245 2032128

Torus 20FX 35FX 70FX 100FX

2032460 2032461 2032462 Glare Shield 2032463 2032464 2032465 Barn Door

1 2032463 2032464 2032465

2 2032460 2032461 2032462 2032463 2032464 2032465

3 2032463 2032464 2032465

Torus 20FX 35FX 70FX 100FX
2032466 2032467 2032468 Gel Holder

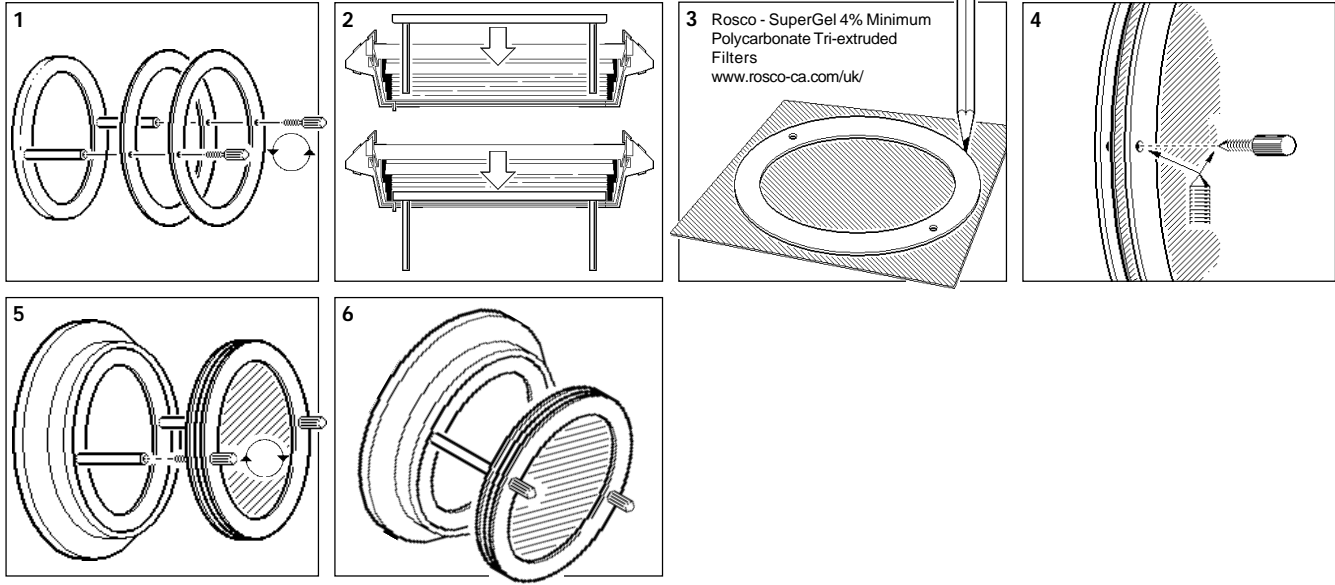

Torus 100

2020177 2020178 2020176 2020179 2020180

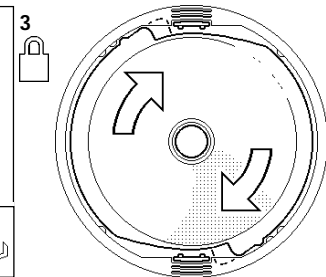
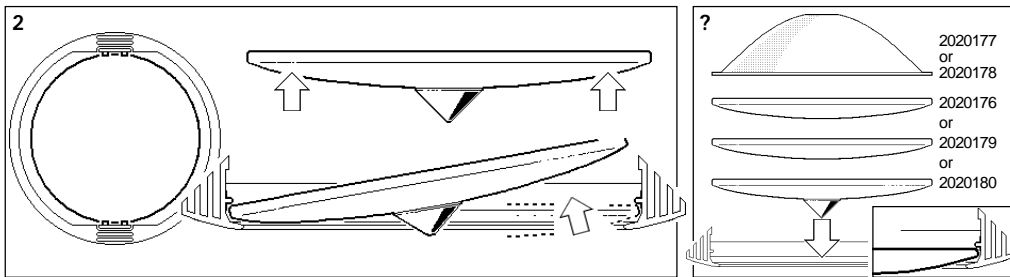
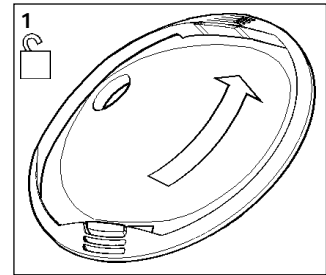
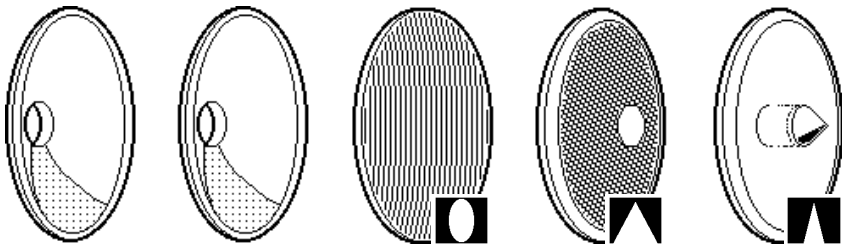

Converting Torus 100 to Torus 100FX

Torus 100

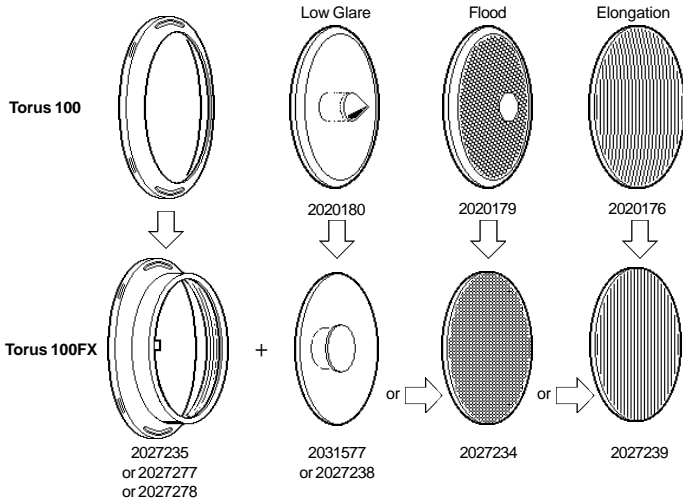
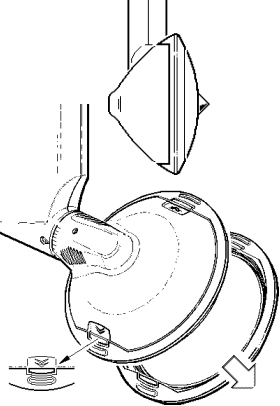

Suitable for use indoors
Geeignet für Innenanwendung
Pour un usage interne
Adecuada para uso en interiores
Geschikt voor gebruik binnen
Lämpligt för inomhusbruk



Replace any cracked protective shield.

Dieses symbol bedeutet, dass defekte Schutzgläser sofort ersetzt werden müssen.

Ce symbol indique que vous devez remplacer tout verre de protection fêlé.

Este simbolo indica que hay que reemplazar filtros en caso de rotura o desperfectos.

Dette symbolet indikerer at alle ødelagte (sprukne) sikkerhetsglass må skiftes.

Valaisinta el saa käyttää ilman suojalasia vioittunut suojalasi on vaihdettava uuteen ennen valaisimen käyttöön ottoa.

< Millimetres >

This Electrical Product
MUST be recycled.



01.09

Concord

Avis Way Newhaven East Sussex BN9 0ED
T 0870 606 2030 F 01273 512 688 email: information@concordmarlin.com



© Concord Lighting Ltd.