

**Tridonic or Harvard or PHILIPS**  
 2031574 - 35W 0.4Kg  
 2031575 - 70W 0.4Kg  
 2031576 - 150W 0.65Kg

These Electronic Control Gearboxes are also supplied as part of **Concord** installer packs.

**Disconnect from mains supply before replacing the fuse or the lamp.**  
 Vor dem Einsetzen der Sicherung oder der Lampe Spannungsfreiheit herstellen.  
**Débrancher le secteur avant de remplacer le fusible ou l'ampoule.**  
 Desconectar del suministro de la red, antes de realizar la sustitución del fusible o de la lámpara.  
**Voor het vervangen van lamp of zekering, eerst netspanning uitschakelen.**  
 Koppla bort spänningen före byte av en säkring eller en lampa.

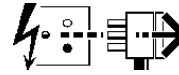

**Switch Off**  
 Abschalten  
**Couper le connectar**  
 Desconectar  
**Uitschakelen**  
 Stäng av

## Tridonic

t = 180°C

**INPUT**  
 220-240V~ 50/60Hz  
 3 x 1.0mm<sup>2</sup> Min

**OUTPUT - Lamp**  
 3 x 1.0mm<sup>2</sup> x (L=5.0M Max)  
 (400pf. Max) 5 kV

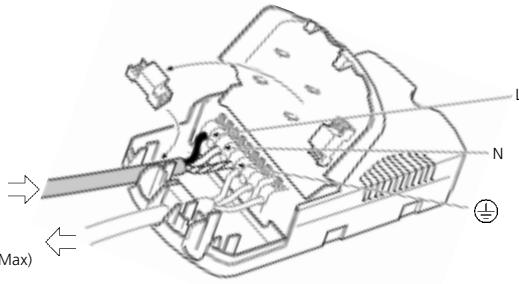

## Tridonic

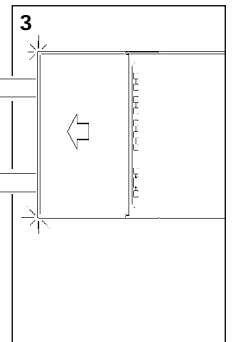
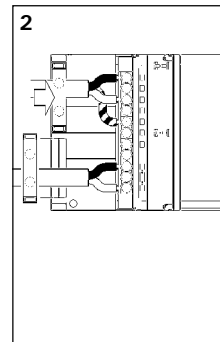
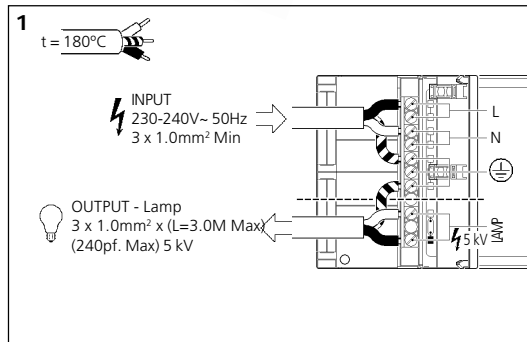
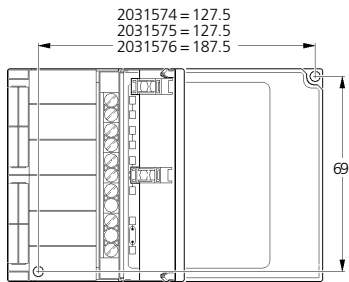

## Tridonic

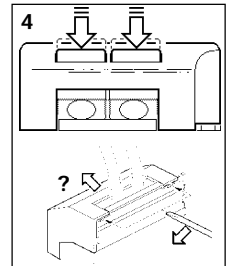
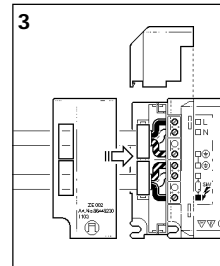
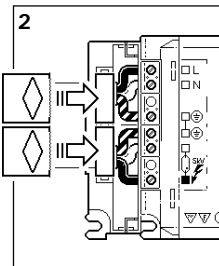
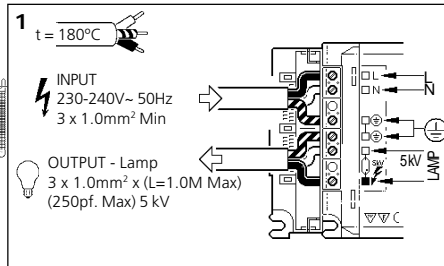
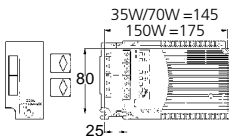

## Harvard

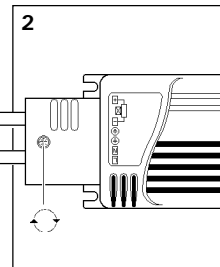
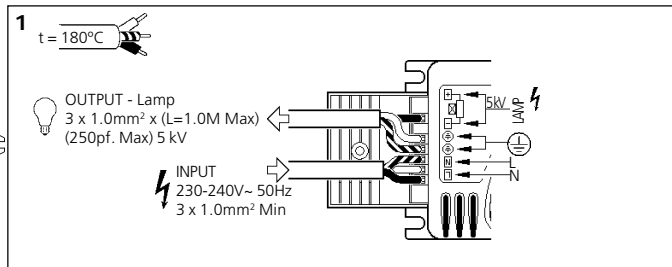
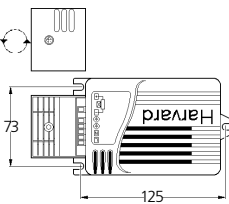

## PHILIPS

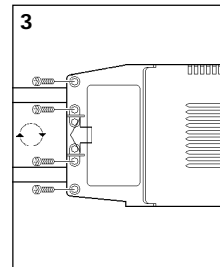
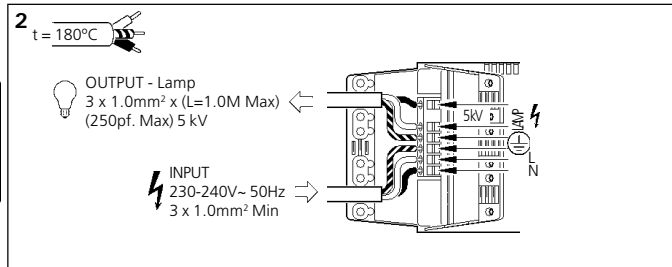
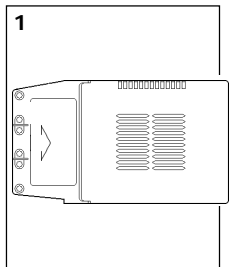

**Suitable for use indoors**  
 Geeignet für Innenanwendung  
**Pour un usage interne**  
 Adecuada para uso en interiores  
**Geschikt voor gebruik binnen**  
 Lämpig för inomhusbruk



< Millimetres >



09.10

# Concord

Avis Way Newhaven East Sussex BN9 0ED  
 T 0870 606 2030 F 01273 512 688 email: information@concordmarlin.com

