

Installer Pack

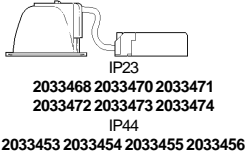

**Disconnect from mains supply before replacing the fuse or the lamp.**  
 Vor dem Einsetzen der Sicherung oder der Lampe Spannungsfreiheit herstellen.  
**Débrancher le secteur avant de remplacer le fusible ou l'ampoule.**  
 Desconectar del suministro de la red, antes de realizar la sustitución del fusible o de la lámpara.  
**Voor het vervangen van lamp of zekering, eerst netspanning uitschakelen.**  
 Koppla bort spänningen före byte av en säkring eller en lampa.

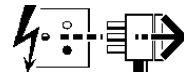

**Switch Off**  
 Abschalten  
**Couper le connecteur**  
 Desconectar  
**Uitschakelen**  
 Stäng av

**NO DIMMERS**

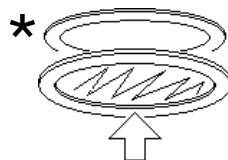
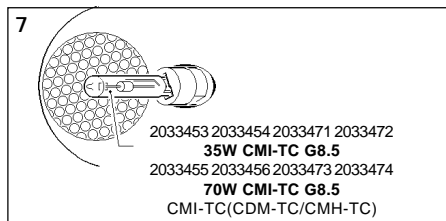
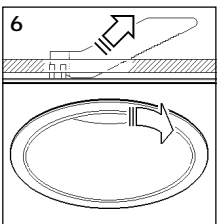
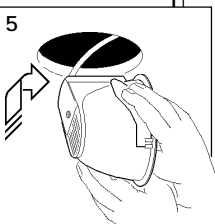
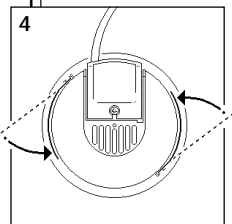
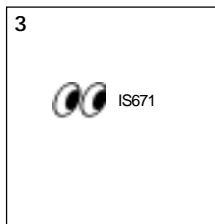
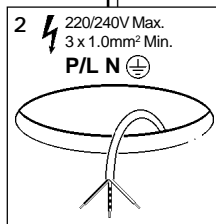
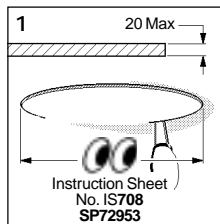
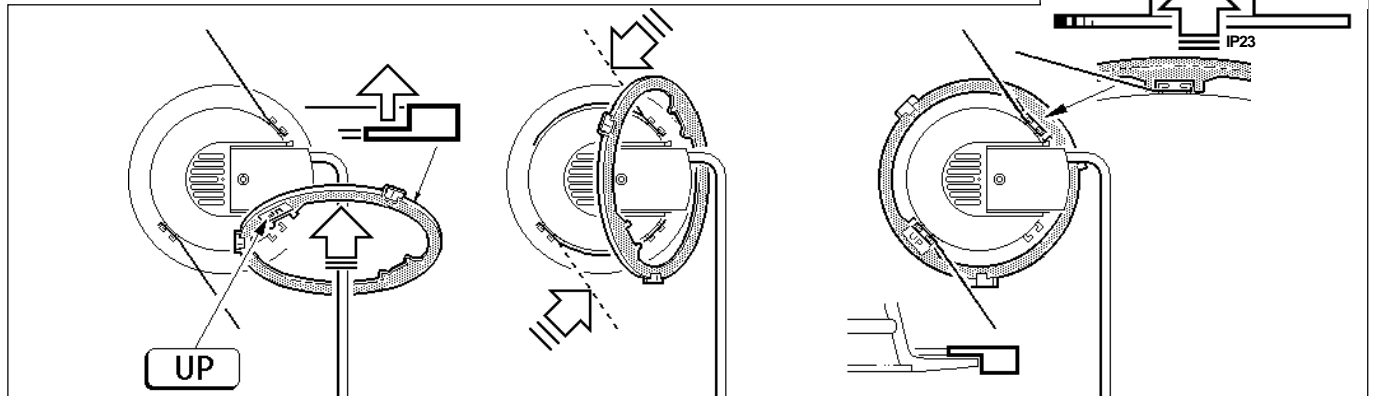
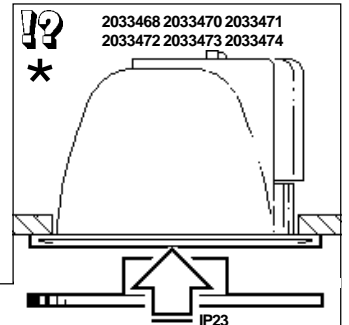
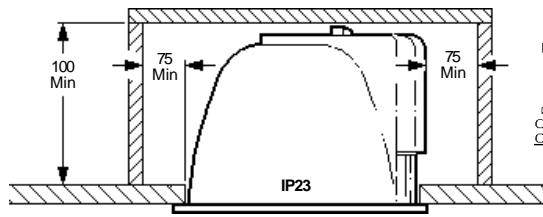

ARCHITECTURAL Accessories

Bezel ~~2028037 2028613~~

Etched Glass ✓  
2028535 2028601 (IP44)

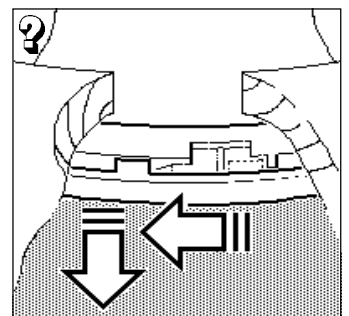
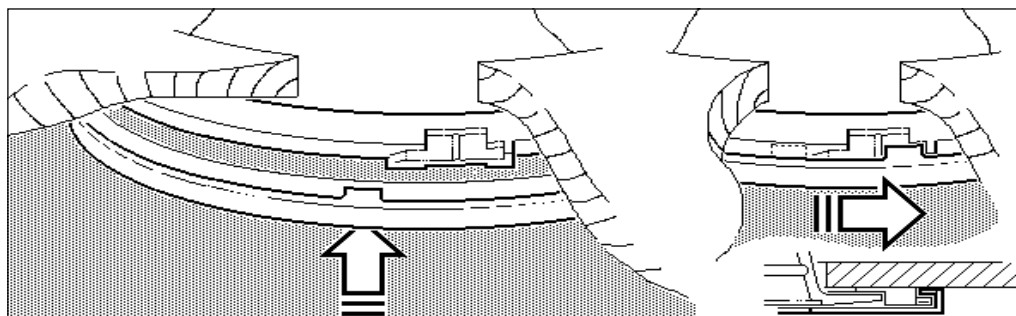

LED is a registered trade mark: UK2009652 A&B, International 659097 and is protected by the following Design Registration: Taiwan 85302887

**Suitable for use indoors**  
 Geeignet für Innenanwendung  
**Pour un usage interne**  
 Adecuada para uso en interiores  
**Geschikt voor gebruik binnen**  
 Lämplig för inomhusbruk



**Replace any cracked protective shield.**  
 Dieses symbol bedeutet, dass defekte Schutzgläser sofort ersetzt werden müssen.  
**Ce symbole indique que vous devez remplacer tout verre de protection fêlé.**  
 Este simbolo indica que hay que reemplazar filtros en caso de rotura o desperfectos.  
**Dette symbolet indikerer at alle ødelagte (sprukne) sikkerhetglass må skiftes.**  
 Valaisinta ei saa käyttää ilman suojalasia vioitunut suojalasi on vaihdettava uuteen ennen valaisimen käyttöön ottoa.

< Millimetres >

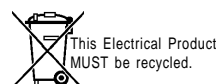

**Concord**

Avis Way Newhaven East Sussex BN9 0ED  
 T 0870 606 2030 F 01273 512 688 email: information@concordmarlin.com

07.08  
  
 © Concord Lighting Ltd.