

35w  
2035052 2035053  
2035054 2035055  
70w  
2035056 2035057  
2035058 2036511

**Disconnect from mains supply before replacing the fuse or the lamp.**  
Vor dem Einsetzen der Sicherung oder der Lampe Spannungsfreiheit herstellen.  
**Débrancher le secteur avant de remplacer le fusible ou l'ampoule.**  
Desconectar del suministro de la red, antes de realizar la sustitución del fusible o de la lámpara.  
**Voor het vervangen van lamp of zekering, eerst netspanning uitschakelen.**  
Koppla bort spänningen före byte av en säkring eller en lampa.

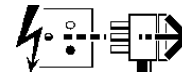

**Switch Off**  
Abschalten  
**Débrancher**  
Desconectar  
**Uitschakelen**  
Stäng av

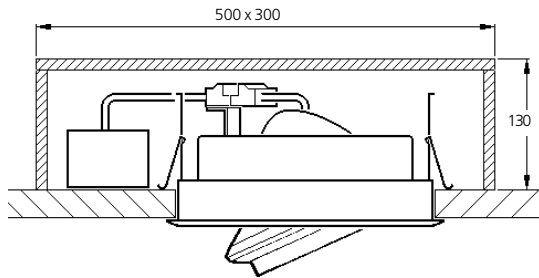

NO INSULATION

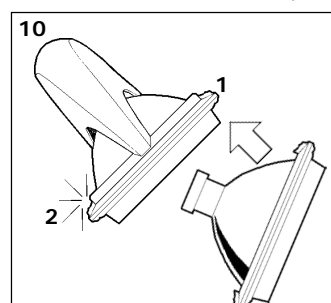
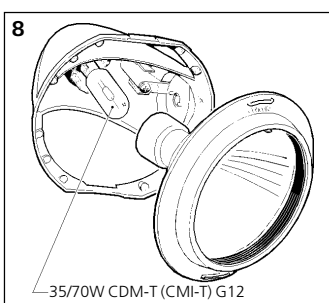
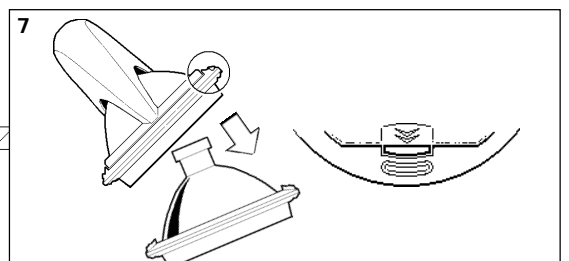
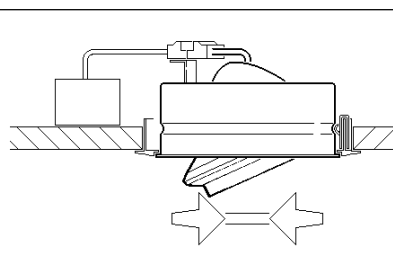
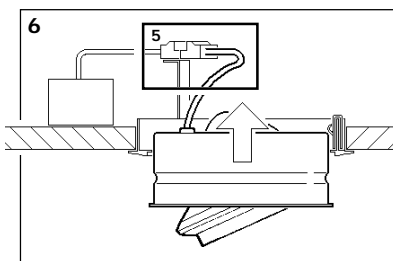
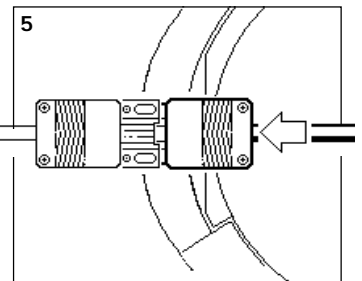
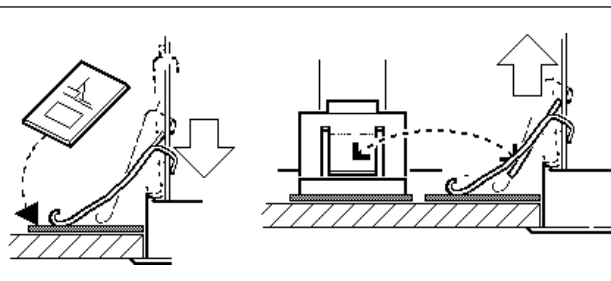
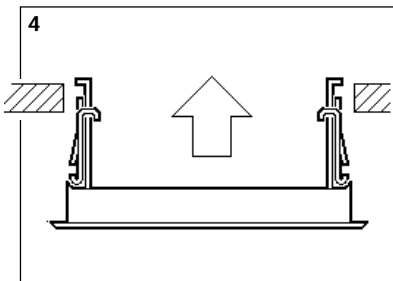
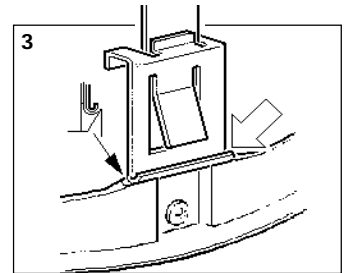
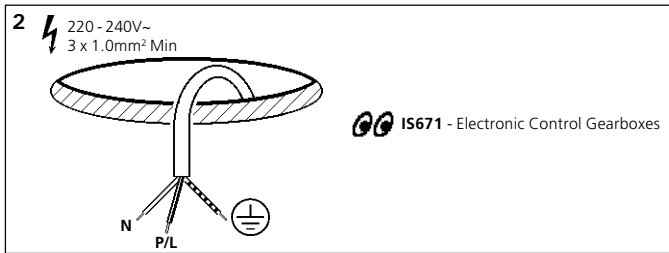
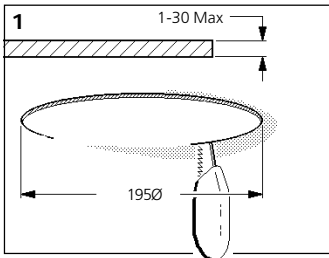
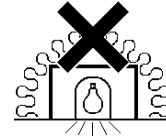

**Suitable for use indoors**  
Geeignet für Innenanwendung  
**Pour un usage interne**  
Adecuada para uso en interiores  
**Geschikt voor gebruik binnen**  
Lämplig för inomhusbruk



**Replace any cracked protective shield.**

Dieses symbol bedeutet, dass defekte Schutzgläser sofort ersetzt werden müssen.

**Ce symbole indique que vous devez remplacer tout verre de protection fêlé.**

Este símbolo indica que hay que 'reemplazar filtros en caso de rotura o desperfectos'.



**Dette symbolet indikerer at alle ødelagte (sprukne) sikkerhetsglass må skiftes.**

Valaisinta ei saa käyttää ilman suojalasia vioitunut suojalasi on vaihdettava uuteen ennen valaisimen käyttöön ottoa.

< Millimetres >



This Electrical Product **MUST** be recycled.



09.10